

GEDORE



Werkzeuge fürs Leben • Tools for life



Sicheres Arbeiten mit funkenfreiem Werkzeug

2011*12 

*funkenfrei 















Einfach den GEDORE Newsletter unter www.gedore.com abonnieren...



Kennen Sie unsere Einzel-Kataloge...

- 
- 
- 



SERVICE / TECHNIK		2- 9	
SCHRAUBENSCHLÜSSEL FUNKENFREI		10- 33	
KNARRENKÄSTEN UND ZUBEHÖR		34- 51	
SCHRAUBENDREHER FUNKENFREI		52- 57	
ZANGEN FUNKENFREI		58- 63	
HÄMMER / SCHLAGWERKZEUGE FUNKENFREI		64- 73	
MESSER, SPACHTEL, SCHABER FUNKENFREI		74- 79	
BÜRSTEN, SCHRUBBER FUNKENFREI		80- 83	
BEILE, SCHAUFELN, SPATEN, HACKEN FUNKENFREI		84- 89	
KEILE, BRECHSTANGEN FUNKENFREI		90- 95	
SONSTIGE HANDWERKZEUGE FUNKENFREI		96- 99	
SPEZIALARTIKEL FUNKENFREI		100- 103	
INHALTSVERZEICHNIS - IMPRESSUM			

i Info

- Weitere funkenfreie Werkzeuge auf Anfrage.
- Haben Sie Ihr passendes Werkzeug nicht gefunden?
Fragen Sie uns nach Sonderanfertigungen.
- Ihre Probleme sind unsere Aufgaben.



* funkenfrei

Warum funkenfreie Werkzeuge?

➤ GEDORE funkenfreie Werkzeuge werden für den Arbeitseinsatz in allen Bereichen empfohlen, in denen brennbare oder leicht entzündbare Dämpfe, Flüssigkeiten oder Stäube gegeben sind sowie in allen anderen Situationen, in denen Funken eine potentielle Feuer und Explosionsgefahr bedeuten.

Charakteristika GEDORE funkenfreie Werkzeuge:

- Hergestellt aus den bewährten funkenarmen Legierungen Sonderbronze und Kupfer-Beryllium oder anderen, nicht funkenreißenden Werkstoffen (z. B. Holz oder elektrisch leitender Kunststoff)
- Zu Ihrer Sicherheit sind die Schlüssel gegossen und nicht geschmiedet.
- Korrosionsbeständig, auch gegen Salzwasser.
- Werkzeuge aus Kupfer-Beryllium sind antimagnetisch!

Warum Guss?

- Anders als herkömmliche Werkzeuge aus Stahl, ist bei funkenfreiem Werkzeug Schmieden nicht das optimale Herstellungsverfahren. Geschmiedete funkenfreie Werkzeuge sehen zwar elegant aus, haben aber den Nachteil, dass sie bei Überlastung ohne Warnung plötzlich brechen.
- Werden diese Werkstoffe hingegen gegossen, können sie sich bei Überbelastung verbiegen anstatt zu brechen.
- Gegossene funkenfreie Schlüssel haben einen starken Materialquerschnitt und sichern damit eine gleichmäßige Drehmomentübertragung.
- GEDORE funkenfreie Schlüssel sind garantiert aus einer Reinschmelze, ohne Zusatz von Schrott, gefertigt.
- Vorteile: Bessere Elastizität, geringere Sprödigkeit und gleichmäßige Materialeigenschaften





Info

- Je härter ein Werkstoff desto größer die Gefahr der Funkenbildung und der daraus entstehenden Explosion.
- Der Eisen-Anteil in Sonderbronze ist unkritisch, da, wenn überhaupt, nur ein kalter Funke entsteht.
- Der Einsatz von funkenfreien Werkzeugen ist eine Maßnahme:
 - zur Verhinderung von Explosionen
 - zur Vermeidung von Entstehungsbränden
 - sowie das Vermeiden bzw. Fernhalten von Zündquellen (Funkenbildung), die auch beim Einsatz von Handwerkzeugen entstehen können (z. B. Hammer und Meißel)
- Im allgemeinen Sprachgebrauch heißt es „funkenfreie“ oder „funkensichere“ Werkzeuge.
- **Physikalisch betrachtet ist die Bezeichnung „funkenarm“ treffender**, da eine Anwendung dieser Werkzeuge nicht mit 100%iger Sicherheit die Entstehung von zündfähigen Funken verhindert.

Anwendungshinweis

ACHTUNG!

- Anwendungsspezifisch sind funkenfreie Werkzeuge weicher als herkömmliche Werkzeuge. Deshalb muss der Einsatz dieser Werkzeuge mit besonderer Sorgfalt erfolgen.
- Überbeanspruchung muss vermieden werden.
- Der Einsatz von funkenfreien Werkzeugen darf nicht die einzige Schutzmaßnahme in feuer- und explosionsgefährdeten Bereichen sein.
- Zum umfassenden Schutz von Personal und Einrichtung beachten Sie bitte die einschlägigen Sicherheitsvorschriften der verschiedenen Institutionen, z. B. Vorschriften der Berufsgenossenschaften, Anweisungen des Arbeitgebers und die gesetzlichen Vorschriften des jeweiligen Landes.

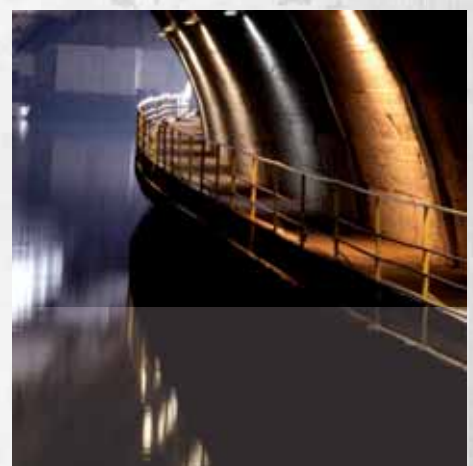
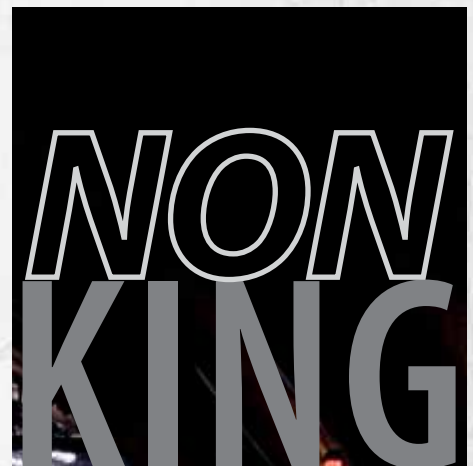

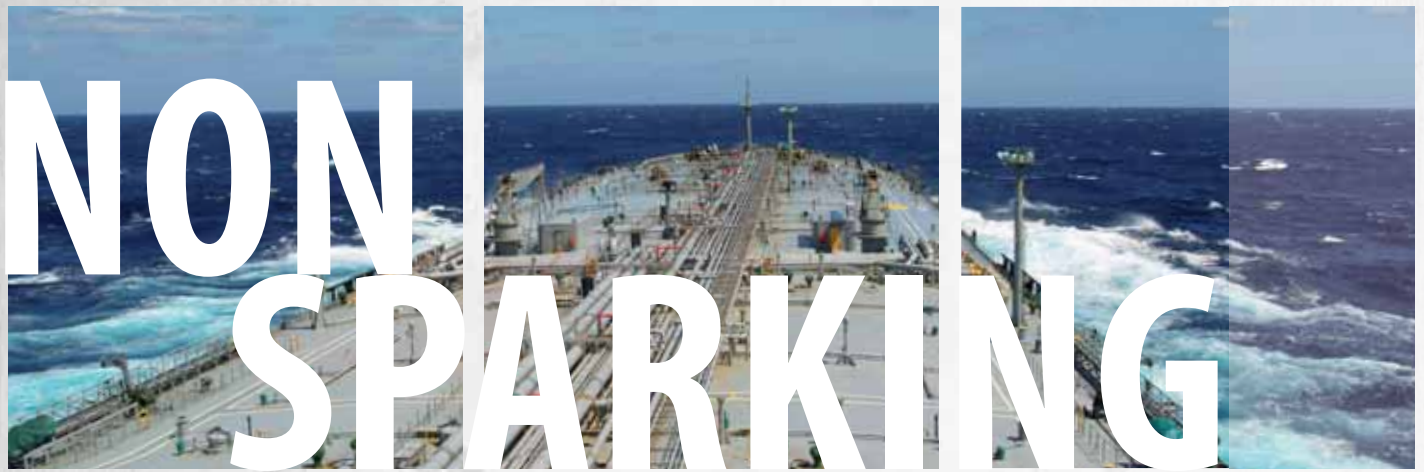

GEDORE-Sicherheitswerkzeuge Nachbearbeitung

- Um GEDORE-Sicherheitswerkzeuge richtig und mit Erfolg nachbearbeiten zu können, muss zunächst die Legierung, aus der das Werkzeug gefertigt ist, eindeutig festgestellt werden.
- Werkzeuge aus Sonderbronze weisen eine gelbliche Farbe auf (Abweichungen der Oberflächenfarbe durch Einwirkung der Atmosphäre, von Chemikalien und auch durch Erwärmung sind möglich), während Werkzeuge aus Kupfer-Beryllium eine rötliche Farbe zeigen und gewöhnlich mit der Legierungsbezeichnung gestempelt sind, z.B. „CuBe“.
- Werkzeuge aus GEDORE-NE-Metall können nachbearbeitet werden und zwar durch Schmieden, regenerierende Schweißmaßnahmen und durch spanabhebende Bearbeitung.
- Diese Nacharbeiten sollten vorzugsweise in unserem Betrieb durchgeführt werden, da im Anschluss an die Arbeiten zu nachfolgenden Punkten „a“ und „b“ auf jeden Fall eine Härteprüfung, wenn nicht sogar Härtung der Werkzeuge folgen muss.
 - a) Das Schmieden geschieht im Temperaturbereich zwischen 785 °C und 900 °C, die günstigste Schmiedetemperatur ist etwa 880 °C. Die Temperaturgrenzen sind genau zu beachten, im Übrigen sind besondere Vorkehrungen nicht notwendig. Die Teile dürfen jedoch nicht abgeschreckt werden, sondern müssen langsam an der Luft abkühlen.
 - b) Das Aufschweißen oder Ausbesserungsschweißen geschieht mittels materialgleichen Schweißzusatzwerkstoffen.
 - c) Auch bei der spanabhebenden Nachbearbeitung sind keine speziellen Vorsichtsmaßnahmen einzuhalten. Es können die gleichen Bearbeitungswerkzeuge und -vorrichtungen verwendet werden wie bei Handwerkzeugen aus Stahl. Nachschleifarbeiten sollten unter guter Kühlung (z.B. Wasser) durchgeführt werden.
- Werkzeuge aus CuBe müssen mit großer Sorgfalt und Vorsicht nachgearbeitet werden. Insbesondere ist dabei zu beachten, dass Staub oder Dämpfe von Kupfer-Beryllium giftig sind und gesundheitliche Schäden hervorrufen können. Ferner verliert Kupfer seine Legierungseigenschaften durch Überhitzung sehr leicht und unter Umständen völlig, so dass der Werkstoff dann nur noch die Eigenschaften gewöhnlichen Kupfers hat.
 - a) Das Nachschmieden von Werkzeugen oder Teilen aus CuBe kann nicht ohne Weiteres empfohlen werden, da das Schmieden in Verbindung mit einer nachträglichen Wärmebehandlung langjähriger Erfahrung bedarf. Bitte fragen Sie uns, ob eine Schmiedung in bestimmten Fällen durchführbar ist.
 - b) Bei der spanabhebenden Bearbeitung, insbesondere beim Schleifen, ist sorgfältig zu kühlen und eine Erwärmung über 250 °C unter allen Umständen zu vermeiden. Die Bearbeitungswerkzeuge müssen einen Spanwinkel von etwa 0° aufweisen, sofern die Bearbeitung im ausgehärteten Zustand erfolgt.





Wichtiger Hinweis

- ▀ Für das Nachschleifen von GEDORE-Sicherheitswerkzeugen aus Kupfer-Beryllium:
- ▀ Beryllium ist ein Metall, das nach der Arbeitsstoff-Verordnung unter die giftigen Arbeitsstoffe fällt!
- ▀ Die betrifft insbesondere Stäube und Dämpfe, die beim Schmelzen, Schleifen und Schweißen entstehen können.
- ▀ Es besteht keine Gefahr, wenn vor allem das Schleifen nass vorgenommen wird!
- ▀ Falls dies in Ausnahmefällen nicht möglich ist, sind folgende Maßnahmen zu beachten:
 1. Staub nicht einatmen (Maske verwenden)
 2. Berührung mit der Haut und den Augen vermeiden
 3. Schutzkleidung tragen
 4. Bei Staub- und Rauchentwicklung wirksames Atemschutzgerät tragen



funkenfrei

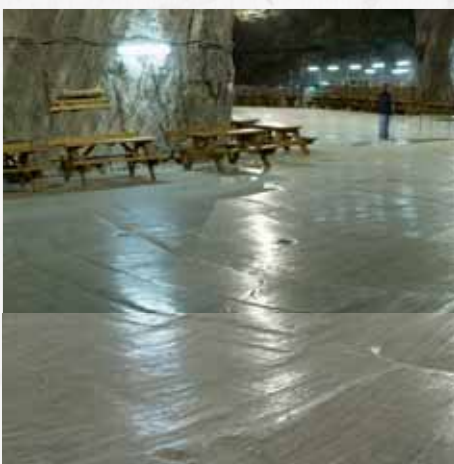

Materialanalyse funkenfreier Werkstoffe

Material	Kupfer-Beryllium			
Analyse	Be	Ni	Co	Cu
min. in %	1,8	0,1	0,4	96,5
max. in %	2,3	0,5	0,7	97,7
Mechanische Eigenschaften	1117 - 1326			
Festigkeit N/mm ²	840 - 880			
Streckgrenze N/mm ²	280/365			
Härte Brinell				

Material	Sonderbronze (Aluminium-Mehrstoff-Bronze)				
Analyse	Cu	Al	Ni	Fe	Mn
min. in %	76	8	4	4	-
max. in %	84	10,5	6	5,5	1,33
Mechanische Eigenschaften	ausgehärtet		unbehandelt		
Festigkeit N/mm ²	780 - 989		600 - 670		
Streckgrenze N/mm ²	450 - 550		250 - 270		
Härte Brinell	230 - 290		140 - 180		

- Alle Werkzeuge mit mechanischer Bewegung, Schneidfunktion oder Belastung der Spitzen (wie Zangen, Knarren, Rollgabelschlüssel, Schraubendreher) werden aus dem härteren CuBe gefertigt, da bei Sonderbronze ansonsten ein zu hoher und schneller Verschleiß auftreten würde.
- Schraubenschlüssel sind meistens aus Sonderbronze gefertigt.



Anwendungshinweis

- Je weicher die Werkzeuge, umso geringer die Wahrscheinlichkeit einer Funkenbildung. Es ist stets der geringste Härtegrad zu wählen, der für die Arbeit gerade noch ausreicht. Durch unser Werkzeugwissen haben wir das schon für Sie erledigt. Für jedes Werkzeug verwenden wir den optimalen Werkstoff. **Werkzeuge mit punktueller Belastung werden aus dem härteren CuBe gefertigt.**

Der Buchstabe am Ende der Artikel-No. steht für den Werkstoff:
 GEDXXXXXXXXS = Werkzeug aus Sonderbronze
 GEDXXXXXXXXC = Werkzeug aus CuBe (Kupfer Beryllium)

funken
funken

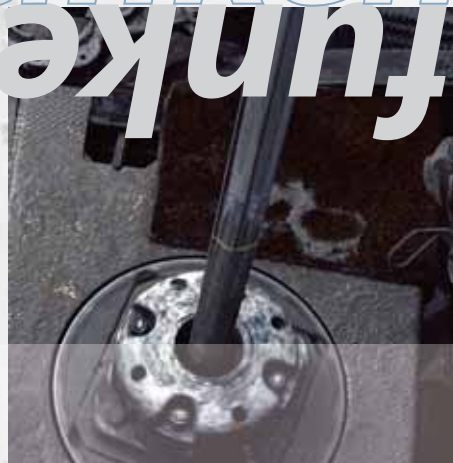
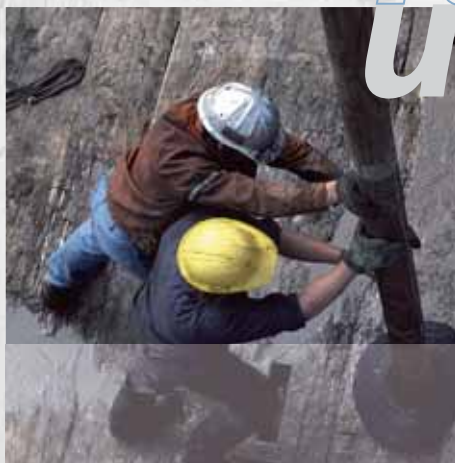

FREI

*funkenfrei



Lexikon der EX-Zonen

Explosionsschutz nach ATEX = Atmosphäre Explosible

- ▶ ATEX 137(118) auch als Richtlinie 99/2/EG bezeichnet, ist zuständig für die Sicherheit der Personen bei Installation, Betrieb und Wartung explosionsgefährdeter Anlagen.
- ▶ Seit Juli 2003 dürfen nur noch Betriebsmittel, die dieser Richtlinie entsprechen, in Verkehr gebracht werden. Gemäß ATEX 99/92/EC kann man GEDORE Werkzeuge in den EX-Zonen anwenden.

INFO:

- ▶ Die ATEX Richtlinie erstreckt sich über Produkte, die auch unter die CE-Richtlinie fallen, z. B. elektrische Produkte, bei deren Nutzung ein Funke entstehen kann. Handwerkzeuge fallen nicht unter die ATEX Richtlinie.
- ▶ EX-Zonen charakterisieren explosionsgefährdete Bereiche in Abhängigkeit von der Häufigkeit und Dauer des Auftretens gefährlicher explosionsfähiger Atmosphäre.

Für Bereiche, die durch brennbare Gase, Dämpfe oder Nebel explosionsgefährdet sind, gelten folgende Zonen:

Zone 0

- ▶ ist ein Bereich, in dem gefährliche explosionsfähige Atmosphäre als Gemisch aus Luft und brennbaren Gasen, Dämpfen oder Nebeln ständig, für lange Zeiträume oder häufig vorhanden ist.

Zone 1

- ▶ ist ein Bereich, in dem sich bei Normalbetrieb gelegentlich eine gefährliche explosionsfähige Atmosphäre als Gemisch aus Luft und brennbaren Gasen, Dämpfen oder Nebeln bilden kann.

Zone 2

- ▶ ist ein Bereich, in dem bei Normalbetrieb eine gefährliche explosionsfähige Atmosphäre als Gemisch aus Luft und brennbaren Gasen, Dämpfen oder Nebeln normalerweise nicht oder aber nur kurzzeitig auftritt.

Für Bereiche, die durch brennbare Stäube explosionsgefährdet sind, gelten folgende Zonen:

Zone 20

- ▶ ist ein Bereich, in dem gefährliche explosionsfähige Atmosphäre in Form einer Wolke aus in der Luft enthaltenem brennbarem Staub ständig, über lange Zeiträume oder häufig vorhanden ist.

Zone 21

- ▶ ist ein Bereich, in dem sich bei Normalbetrieb gelegentlich eine gefährliche explosionsfähige Atmosphäre in Form einer Wolke aus in der Luft enthaltenem brennbarem Staub bilden kann.

Zone 22

- ▶ ist ein Bereich, in dem bei Normalbetrieb eine gefährliche explosionsfähige Atmosphäre in Form einer Wolke aus in der Luft enthaltenem brennbarem Staub normalerweise nicht oder aber nur kurzzeitig auftritt.

Bemerkungen:

- ▶ Der Begriff „häufig“ ist im Sinne von „zeitlich überwiegend“ zu verwenden.
- ▶ Als Normalbetrieb gilt der Zustand, in dem Anlagen innerhalb ihrer Auslegungsparameter benutzt werden.

- ▶ Unter vielen Experten besteht der Konsens, dass der Begriff „kurzzeitig“ einer Zeitdauer von maximal 30 Minuten entspricht.
- ▶ Schichten, Ablagerungen und Aufhäufungen von brennbarem Staub sind wie jede andere Ursache, die zur Bildung einer gefährlichen

explosionsfähigen Atmosphäre führen kann, zu berücksichtigen.

- ▶ Diese Zonendefinitionen gelten auf der Basis der Richtlinie 1999/92/EG in allen EU-Mitgliedstaaten gleichermaßen.

Quelle BG RCI (Rohstoffe und chemische Industrie)

SCHRAUBEN



NON
SPARKING



SCHLÜSSEL



SCHRAUBENSCHLÜSSEL



*funkenfrei

SCHRAUBENSCHLÜSSEL FUNKENFREI

MAULSCHLÜSSEL FUNKENFREI



GED001

DOPPELMAULSCHLÜSSEL

- ▶ Ähnlich DIN 3110
- ▶ Mit flachen Köpfen und griffigem Schaft



Code	No.	Ø mm	l mm	l mm
2502550	GED0010607S	6 x 7	125	65
2502542	GED0010608S	6 x 8	125	65
2502534	GED0010708S	7 x 8	125	65
2502526	GED0010709S	7 x 9	125	65
2502518	GED0010809S	8 x 9	125	65
2498529	GED0010810S	8 x 10	125	60
2498510	GED0010910S	9 x 10	125	60
2498502	GED0010911S	9 x 11	140	90
2495317	GED0011011S	10 x 11	140	90
2495309	GED0011012S	10 x 12	140	85
2495295	GED0011013S	10 x 13	140	80
2495287	GED0011014S	10 x 14	160	180
2495279	GED0011113S	11 x 13	160	180
2495244	GED0011114S	11 x 14	160	180
2495236	GED0011213S	12 x 13	160	180
2495228	GED0011214S	12 x 14	160	170
2495201	GED0011315S	13 x 15	160	170
2495198	GED0011415S	14 x 15	200	165
2495171	GED0011416S	14 x 16	200	220
2495163	GED0011417S	14 x 17	200	220
2495155	GED0011617S	16 x 17	200	210
2495147	GED0011618S	16 x 18	200	210
2495139	GED0011719S	17 x 19	225	350
2495112	GED0011722S	17 x 22	225	320
2495104	GED0011819S	18 x 19	225	320
2495090	GED0011820S	18 x 20	225	310
2495082	GED0011821S	18 x 21	225	300
2495074	GED0011922S	19 x 22	240	440
2495066	GED0011924S	19 x 24	240	420
2495058	GED0012022S	20 x 22	240	440
2495031	GED0012123S	21 x 23	240	420
2495023	GED0012224S	22 x 24	240	420
2495015	GED0012227S	22 x 27	270	730
2494981	GED0012326S	23 x 26	270	730
2494973	GED0012426S	24 x 26	270	730
2494965	GED0012427S	24 x 27	270	730
2494957	GED0012430S	24 x 30	270	700
2494949	GED0012528S	25 x 28	270	700
2494930	GED0012629S	26 x 29	270	700
2494922	GED0012729S	27 x 29	300	810
2494914	GED0012730S	27 x 30	300	800
2494906	GED0012732S	27 x 32	300	800
2494892	GED0013032S	30 x 32	300	780
2494876	GED0013034S	30 x 34	320	1240
2494868	GED0013036S	30 x 36	320	1220
2494841	GED0013234S	32 x 34	320	1200
2494833	GED0013236S	32 x 36	320	1140
2494825	GED0013436S	34 x 36	320	1100
2494817	GED0013538S	35 x 38	370	1480

Code	No.	Ø mm	l mm	l mm
2494809	GED0013641S	36 x 41	370	1480
2494795	GED0014146S	41 x 46	370	1450
2494787	GED0014650S	46 x 50	390	1400
2494779	GED0015055S	50 x 55	440	1700
2494752	GED0015060S	50 x 60	440	1700
2494744	GED0015560S	55 x 60	470	1800
2494736	GED0016065S	60 x 65	470	1800
2494728	GED0016570S	65 x 70	630	3500
2494701	GED0017080S	70 x 80	630	3400
2494523	GED0017580S	75 x 80	630	3300

GED0010

DOPPELMAULSCHLÜSSEL-SATZ, 12-TEILIG

- ▶ Ähnlich DIN 3110
- ▶ Mit flachen Köpfen und griffigem Schaft
- ▶ In praxiserrechter Zusammenstellung



Code	No.	Inhalt	l mm
2516667	GED0010000S	6x7 8x9 10x11 12x13 14x15 16x17 18x19 20x22 21x23 24x27 25x28 30x32	3500



GED0017

DOPPELMAULSCHLÜSSEL ZOLL

- ▶ Ähnlich DIN 3110
- ▶ Mit flachen Köpfen und griffigem Schaft



AF

Code	No.	AF	(mm)	Stk
2516586	GED00171405	7/32 x 1/4	125	65
2516659	GED00171015	1/4 x 5/16	125	65
2498499	GED00171025	5/16 x 3/8	125	60
2516640	GED00171035	3/8 x 7/16	140	90
2516632	GED00171045	7/16 x 1/2	140	85
2521326	GED00171135	1/2 x 5/8	160	170
2516616	GED00171055	1/2 x 9/16	160	170
2498464	GED00171145	1/2 x 11/16	200	220
2498480	GED00171065	9/16 x 5/8	200	220
2498456	GED00171155	9/16 x 3/4	200	220
2494698	GED00171075	19/32 x 11/16	200	220
2494671	GED00171165	19/32 x 25/32	200	220
2498472	GED00171085	5/8 x 11/16	200	200
2521369	GED00171095	5/8 x 3/4	225	310
2521318	GED00171175	11/16 x 25/32	225	300
2498448	GED00171185	11/16 x 7/8	225	300
2521350	GED00171105	3/4 x 7/8	225	300
2498421	GED00171195	3/4 x 25/32	225	300
2498405	GED00171205	3/4 x 13/16	225	310
2521210	GED00171415	3/4 x 7/8	225	310
2494663	GED00171215	25/32 x 13/16	225	300
2498391	GED00171225	25/32 x 7/8	225	300
2498383	GED00171235	13/16 x 7/8	225	300
2498375	GED00171245	7/8 x 15/16	225	300
2498367	GED00171255	7/8 x 31/32	240	400
2498359	GED00171265	7/8 x 1	240	400
2494655	GED00171275	7/8 x 1.1/16	270	720
2521342	GED00171115	15/16 x 1	270	720
2521296	GED00171285	15/16 x 1.1/16	270	720
2521288	GED00171295	1 x 1.1/8	270	700
2516608	GED00171305	1 x 1.5/16	300	750
2521334	GED00171125	1.1/16 x 1.1/4	300	750
2521261	GED00171315	1.1/8 x 1.5/16	300	750
2516578	GED00171425	1.1/16 x 1.7/16	320	1220
2494647	GED00171325	1.1/8 x 1.1/2	320	1150
2494620	GED00171335	1.1/4 x 1.3/8	320	1150
2521253	GED00171345	1.1/4 x 1.7/16	320	1150
2521237	GED00171355	1.5/16 x 1.1/2	370	1480
2494612	GED00171365	1.1/4 x 1.5/8	370	1400
2494604	GED00171375	1.3/8 x 1.1/2	370	1400
2521229	GED00171385	1.7/16 x 1.5/8	370	1400
2516594	GED00171395	1.1/2 x 1.11/16	370	1400
2516551	GED00171435	1.5/8 x 14	370	1400
2494590	GED00171445	1.5/8 x 1.3/4	370	1350
2516543	GED00171455	1.11/16 x 1.7/8	370	1350
2498340	GED00171465	1.11/16 x 2	390	1700
2498332	GED00171475	1.13/16 x 2	390	1700
2521202	GED00171485	1.3/4 x 2.1/16	390	1700
2498324	GED00171495	2 x 2.3/16	440	1700
2498316	GED00171505	2 x 2.5/16	440	1700
2521199	GED00171515	2.3/16 x 2.3/8	470	1800
2494582	GED00171525	2.1/4 x 2.3/8	470	1800

GED0010

DOPPELMAULSCHLÜSSEL-SATZ ZOLL, 8-TEILIG

- ▶ Ähnlich DIN 3110
- ▶ Mit flachen Köpfen und griffigem Schaft
- ▶ In praxisgerechter Zusammenstellung



AF

Code	No.	Inhalt	Stk
2521385	GED00100015	1/4x5/16 3/8x7/16 7/16x1/2 1/2x9/16 9/16x5/8 5/8x11/16 3/4x7/8 15/16x1AF	1700



GED00172

BLECH-DOPPELMAULSCHLÜSSEL KLEIN

- ▶ Aus Blech gestanz
- ▶ Mit gleichen Schlüsselweiten
- ▶ Versetzte Maulstellung (75° und 15°) für schwierige Anwendungsbereiche



mm

Code	No.	mm	(mm)	Stk
2502496	GED00172045	4	70	7
2498278	GED00172015	4,5	70	7
2502488	GED00172055	5	78	7
2498251	GED00172025	5,5	78	10
2502461	GED00172065	6	78	10
2502453	GED00172075	7	91	10
2502445	GED00172085	8	96	15
2502429	GED00172095	9	103	15
2498243	GED00172105	10	105	20
2498235	GED00172115	11	116	20
2498227	GED00172125	12	116	35
2498219	GED00172135	13	131	35
2498200	GED00172145	14	131	35

GED00172

BLECH-DOPPELMAULSCHLÜSSEL-SATZ KLEIN, 10-TEILIG

- ▶ In praxisgerechter Zusammenstellung



mm

Code	No.	Inhalt	Stk
2516535	GED00172005	5 5,5 6 7 8 9 10 11 12 13	180

GED00171

BLECH-DOPPELMAULSCHLÜSSEL

► Aus Blech gestanzt



 mm

Code	No.	Ø mm	l mm	↓ ↑
2494574	GED0017153S	3 x 3,5	50	5
2494566	GED0017154S	4 x 4,5	60	5
2494558	GED0017155S	5 x 5,5	70	6
2498294	GED0017156S	6 x 7	80	8
2498286	GED0017157S	8 x 9	90	10
2494531	GED0017158S	10 x 11	100	12

GED00171

BLECH-DOPPELMAULSCHLÜSSEL ZOLL

► Aus Blech gestanzt



 "AF"

Code	No.	Ø "AF"	l mm	↓ ↑
2493667	GED0017159S	5/32 x 3/16	60	5
2493543	GED0017160S	3/16 x 7/32	70	6
2510871	GED0017161S	1/4 x 9/32	80	8
2510766	GED0017162S	1/4 x 5/16	80	8
2518937	GED0017163S	5/16 x 11/32	90	10
2510642	GED0017164S	5/16 x 3/8	90	10
2518813	GED0017165S	5/16 x 13/32	100	12
2510510	GED0017166S	3/8 x 7/16	100	12

GED0020

EINMAULSCHLÜSSEL

► Extra langer Schaft für tiefen Einsatzbereich
 ► Sicherer Griff durch Profilschaft



 mm

Code	No.	Ø mm	l mm	↓ ↑
2512157	GED0020006S	6	90	14
2512149	GED0020007S	7	90	13
2512130	GED0020008S	8	90	12
2512122	GED0020009S	9	90	11
2511592	GED0020010S	10	100	25
2511584	GED0020011S	11	100	22
2511576	GED0020012S	12	140	45
2511568	GED0020013S	13	140	40
2511541	GED0020014S	14	165	80

Code	No.	Ø mm	l mm	↓ ↑
2511533	GED0020015S	15	145	75
2511525	GED0020016S	16	165	70
2511517	GED0020017S	17	165	70
2511495	GED0020018S	18	165	70
2511487	GED0020019S	19	190	100
2511479	GED0020020S	20	190	95
2511460	GED0020021S	21	205	140
2511452	GED0020022S	22	205	130
2511444	GED0020023S	23	220	170
2511436	GED0020024S	24	220	170
2511428	GED0020025S	25	220	160
2511401	GED0020026S	26	220	160
2511398	GED0020027S	27	220	150
2511363	GED0020028S	28	250	270
2511355	GED0020029S	29	250	260
2511347	GED0020030S	30	250	250
2511339	GED0020032S	32	285	340
2511320	GED0020033S	33	285	340
2511312	GED0020034S	34	285	320
2511304	GED0020035S	35	285	320
2511290	GED0020036S	36	285	300
2511282	GED0020037S	37	285	300
2511274	GED0020038S	38	330	540
2511258	GED0020041S	41	330	520
2511231	GED0020042S	42	330	500
2511223	GED0020046S	46	360	650
2511215	GED0020047S	47	360	630
2511207	GED0020050S	50	440	1100
2511193	GED0020052S	52	440	1100
2511185	GED0020054S	54	440	1050
2511177	GED0020055S	55	440	1050
2511169	GED0020056S	56	440	1000
2511150	GED0020058S	58	480	1475
2511126	GED0020060S	60	480	1475
2511118	GED0020063S	63	520	1700
2511096	GED0020065S	65	520	1700
2511088	GED0020067S	67	520	1700
2511061	GED0020070S	70	540	1900
2511053	GED0020071S	71	540	1900
2511045	GED0020075S	75	540	1800
2511037	GED0020077S	77	540	1800
2511029	GED0020080S	80	630	2900
2511010	GED0020082S	82	630	2800
2510995	GED0020085S	85	680	3400
2510987	GED0020088S	88	680	3300
2510979	GED0020090S	90	680	3200
2510960	GED0020094S	94	830	5000
2510952	GED0020095S	95	830	4800
2509377	GED0020100S	100	800	5900
2509369	GED0020105S	105	850	8900
2509350	GED0020110S	110	900	9000
2509342	GED0020115S	115	950	9300
2509334	GED0020120S	120	990	9600
2509326	GED0020125S	125	1000	8300
2509318	GED0020130S	130	1000	8300
2509288	GED0020135S	135	1000	8300



GED0021

EINMAULSCHLÜSSEL ZOLL

- ▶ Extra langer Schaft für tiefen Einsatzbereich
- ▶ Sicherer Griff durch Profilschaft



 "AF"

Code	No.	○ ^{AF}	(+mm-)	↕
2510944	GED0021001S	1/4	90	14
2510936	GED0021002S	5/16	90	12
2507374	GED0021003S	11/32	90	11
2510928	GED0021004S	3/8	90	11
2507366	GED0021005S	13/32	100	25
2509261	GED0021006S	7/16	100	22
2510901	GED0021007S	1/2	140	40
2509253	GED0021008S	9/16	165	80
2507358	GED0021009S	19/32	165	75
2510898	GED0021010S	5/8	165	70
2507323	GED0021011S	11/16	165	70
2509245	GED0021012S	3/4	190	100
2507315	GED0021013S	25/32	190	95
2507307	GED0021014S	13/16	205	140
2510863	GED0021015S	7/8	205	130
2507293	GED0021016S	15/16	220	170
2507285	GED0021017S	31/32	220	170
2513064	GED0021018S	1	220	160
2505444	GED0021019S	1.1/16	220	150
2507277	GED0021020S	1.1/8	250	270
2505436	GED0021021S	1.3/16	250	250
2507269	GED0021022S	1.1/4	285	340
2505428	GED0021023S	1.5/16	285	340
2507250	GED0021024S	1.3/8	285	320
2505401	GED0021025S	1.7/16	285	300
2507242	GED0021026S	1.1/2	330	540
2505371	GED0021027S	1.9/16	330	520
2507234	GED0021028S	1.5/8	330	520
2502402	GED0021029S	1.11/16	330	500
2507218	GED0021030S	1.3/4	360	650
2502399	GED0021031S	1.13/16	360	650
2507196	GED0021032S	1.7/8	360	630
2513056	GED0021033S	2	440	1100
2505363	GED0021034S	2.1/16	440	1100
2507188	GED0021035S	2.1/8	440	1050
2505355	GED0021036S	2.3/16	440	1050
2507161	GED0021037S	2.1/4	480	1000
2505347	GED0021038S	2.5/16	480	1475
2507153	GED0021039S	2.3/8	480	1475
2505339	GED0021040S	2.7/16	520	1700
2507145	GED0021041S	2.1/2	520	1700
2505320	GED0021042S	2.9/16	520	1700
2507137	GED0021043S	2.5/8	520	1700
2507129	GED0021044S	2.3/4	540	1900
2502380	GED0021045S	2.13/16	540	1900
2502372	GED0021046S	2.15/16	540	1900
2513048	GED0021047S	3	540	1800
2507110	GED0021048S	3.1/8	630	2900
2507102	GED0021049S	3.1/4	630	2800
2507080	GED0021050S	3.3/8	680	3400
2507072	GED0021051S	3.1/2	680	3300
2507064	GED0021052S	3.5/8	680	3200
2507056	GED0021053S	3.3/4	830	5000
2507048	GED0021054S	3.7/8	830	4800

RING-MAULSCHLÜSSEL FUNKENFREI

GED0130

RING-MAULSCHLÜSSEL

- ▶ Mit gleichen Schlüsselweiten, Ring 12-kant



 mm



Code	No.	○ mm	(+mm-)	↕
2510855	GED0130006S	6	130	50
2510847	GED0130007S	7	130	55
2510839	GED0130008S	8	135	55
2510820	GED0130009S	9	150	95
2509148	GED0130010S	103	150	85
2509121	GED0130011S	11	150	90
2509113	GED0130012S	12	190	170
2509105	GED0130013S	13	190	165
2509091	GED0130014S	14	190	160
2509083	GED0130015S	15	210	230
2509075	GED0130016S	16	210	230
2509067	GED0130017S	17	210	220
2509040	GED0130018S	18	230	330
2509032	GED0130019S	19	230	330
2509024	GED0130020S	20	230	325
2509016	GED0130021S	21	250	360
2509008	GED0130022S	22	250	355
2508990	GED0130023S	23	250	350
2508982	GED0130024S	24	270	500
2508974	GED0130025S	25	270	475
2508966	GED0130026S	26	270	470
2508958	GED0130027S	27	280	665
2508923	GED0130028S	28	280	680
2508915	GED0130029S	29	280	630
2508907	GED0130030S	30	300	730
2508893	GED0130032S	32	300	650
2508885	GED0130034S	34	320	950
2508877	GED0130036S	36	330	930
2508869	GED0130038S	38	400	2150
2508850	GED0130041S	41	410	2000
2508842	GED0130046S	46	410	1900
2508834	GED0130050S	50	540	3400
2508818	GED0130055S	55	520	3500
2508796	GED0130060S	60	515	3300
2508788	GED0130065S	65	500	3200
2508761	GED0130070S	70	510	3800
2508753	GED0130075S	75	680	3900
2508745	GED0130080S	80	680	4000

GED0130

RING-MAULSCHLÜSSEL-SATZ

- ▶ In praxiserrechter Zusammenstellung



 mm

Code	No.	Inhalt	-teilig	↕
2497492	GED0130002S	8 9 10 11 13 14 17 19	8	1200
2493551	GED0130003S	8 10 11 12 13 14 16 17 18 19 22	11	2200
2493578	GED0130001S	10 11 12 13 14 17 19 22 24 27 30 32	12	4100
2493586	GED0130000S	6 7 8 9 10 11 12 13 14 15 16 17 18 19 20 21 22 23 24 25 26 27 28 29 30 32	26	8450

GED0137

RING-MAULSCHLÜSSEL ZOLL

► Mit gleichen Schlüsselweiten, Ring 12-kant



 "AF

Code	No.	Ø "AF"	(-mm-)	↕
2508737	GED0137101S	1/4	135	45
2506998	GED0137102S	5/16	135	45
2504219	GED0137118S	11/32	150	60
2508729	GED0137103S	3/8	150	60
2506971	GED0137104S	7/16	150	60
2508710	GED0137105S	1/2	190	110
2506955	GED0137106S	9/16	190	110
2504286	GED0137107S	19/32	210	200
2508702	GED0137108S	5/8	210	200
2504278	GED0137109S	11/16	230	230
2508672	GED0137110S	3/4	230	230
2504200	GED0137119S	25/32	230	230
2504251	GED0137111S	13/16	250	300
2508664	GED0137112S	7/8	250	300
2504243	GED0137113S	15/16	270	410
2504197	GED0137120S	31/32	270	410
2512114	GED0137114S	1	270	410
2501139	GED0137115S	1.1/16	280	510
2504235	GED0137116S	1.1/8	280	510
2501120	GED0137121S	1.3/16	300	570
2504227	GED0137117S	1.1/4	300	570
2501112	GED0137122S	1.5/16	300	570
2504189	GED0137123S	1.3/8	330	840
2501090	GED0137124S	1.7/16	330	840
2504162	GED0137125S	1.1/2	330	840
2501082	GED0137126S	1.9/16	410	2000
2504154	GED0137127S	1.5/8	410	2000
2497484	GED0137128S	1.11/16	410	2000
2504146	GED0137129S	1.3/4	410	1900
2497476	GED0137130S	1.13/16	410	1900
2504138	GED0137131S	1.7/8	435	1600
2512092	GED0137132S	2	435	1600
2501074	GED0137133S	2.1/16	435	1600
2504111	GED0137134S	2.1/8	455	2000
2501066	GED0137135S	2.3/16	455	2000
2504103	GED0137136S	2.1/4	475	2500

GED0137

RING-MAULSCHLÜSSEL, EXTRA LANG

► Mit gleichen Schlüsselweiten, Ring 12-kant
 ► Extra langer Schaft für tiefen Einsatzbereich



 mm

Code	No.	Ø mm	(-mm-)	↕
2493527	GED0137140S	10	190	70
2493519	GED0137142S	12	210	70
2493500	GED0137143S	13	225	90
2493497	GED0137147S	17	280	135
2493489	GED0137149S	19	310	200
2493470	GED0137151S	22	350	260
2493462	GED0137153S	24	400	370
2493454	GED0137154S	27	450	500
2493446	GED0137155S	30	480	900
2493411	GED0137156S	32	500	730
2493403	GED0137159S	36	550	1200
2493381	GED0137160S	41	600	2000
2493373	GED0137161S	46	640	2800

GED0137

RING-MAULSCHLÜSSEL-SATZ, EXTRA LANG

► In praxisgerechter Zusammenstellung



 mm

Code	No.	Inhalt	-teilig	↕
2493365	GED0137162S	10 12 13 17 19 22	6	825
2493357	GED0137164S	10 12 13 17 19 22 24 27 30 32	10	3325

GED0137

RING-MAULSCHLÜSSEL-SATZ ZOLL

► In praxisgerechter Zusammenstellung



 "AF

Code	No.	Inhalt	↕
2493535	GED0137100S	1/4 5/16 3/8 7/16 1/2 9/16 5/8 3/4 7/8 1 1.1/16 1.1/4	3300



GED0137

RING-MAULSCHLÜSSEL GEKRÖPFT

- ▣ Mit gleichen Schlüsselweiten
- ▣ Ringseite gekröpft



 mm

Code	No.	Ø mm	l mm	
2508656	GED0137170S	10	148	70
2508648	GED0137172S	12	168	65
2508621	GED0137173S	13	185	80
2508613	GED0137177S	17	232	140
2508605	GED0137179S	19	258	190
2508591	GED0137182S	22	292	300
2508583	GED0137184S	24	318	370
2508575	GED0137187S	27	352	500
2508559	GED0137190S	30	390	645
2508540	GED0137191S	32	412	780

GED0137

RING-MAULSCHLÜSSEL-SATZ GEKRÖPFT

- ▣ In praxisgerechter Zusammenstellung



 mm

Code	No.	Inhalt	-teilig	
2497468	GED0137206S	10 12 13 17 19 22	6	845
2493349	GED0137208S	10 12 13 17 19 22 14 27 30 32	10	3140

RINGSCHLÜSSEL FUNKENFREI

GED011

DOPPELRINGSCHLÜSSEL GEKRÖPFT

- ▣ Gekröpft, 12-kant
- ▣ Spezialist für extrem tiefliegende bzw. versenkte Muttern



 mm

Code	No.	Ø mm	l mm	
2497573	GED0110607S	6 x 7	170	105
2497557	GED0110608S	6 x 8	170	110
2497549	GED0110708S	7 x 8	170	100
2497530	GED0110709S	7 x 9	170	100
2497522	GED0110809S	8 x 9	170	100
2493993	GED0110810S	8 x 10	180	140
2493985	GED0110910S	9 x 10	180	125
2493977	GED0110911S	9 x 11	180	135
2520788	GED0111011S	10 x 11	180	145
2520753	GED0111012S	10 x 12	180	140
2520745	GED0111013S	10 x 13	195	175
2520737	GED0111014S	10 x 14	195	170
2520729	GED0111113S	11 x 13	195	190
2520710	GED0111114S	11 x 14	195	180

Code	No.	Ø mm	l mm	
2520702	GED0111213S	12 x 13	195	180
2520699	GED0111214S	12 x 14	195	180
2520680	GED0111314S	13 x 14	195	175
2520672	GED0111315S	13 x 15	230	240
2520664	GED0111316S	13 x 16	230	240
2520648	GED0111317S	13 x 17	230	250
2520621	GED0111415S	14 x 15	230	250
2520613	GED0111416S	14 x 16	230	240
2520605	GED0111417S	14 x 17	230	230
2520591	GED0111617S	16 x 17	230	240
2520583	GED0111618S	16 x 18	280	420
2520575	GED0111719S	17 x 19	280	400
2520567	GED0111722S	17 x 22	280	380
2520559	GED0111819S	18 x 19	280	400
2520540	GED0111820S	18 x 20	280	390
2520516	GED0111821S	18 x 21	280	390
2520508	GED0111922S	19 x 22	280	370
2520494	GED0111924S	19 x 24	290	530
2520486	GED0112022S	20 x 22	280	380
2520478	GED0112123S	21 x 23	290	510
2520451	GED0112124S	21 x 24	300	510
2520443	GED0112224S	22 x 24	300	510
2520435	GED0112227S	22 x 27	330	650
2520427	GED0112326S	23 x 26	330	670
2520419	GED0112426S	24 x 26	330	680
2520397	GED0112427S	24 x 27	330	670
2520389	GED0112430S	24 x 30	370	930
2520370	GED0112528S	25 x 28	330	660
2520362	GED0112629S	26 x 29	370	1000
2520354	GED0112729S	27 x 29	370	1000
2520346	GED0112730S	27 x 30	370	900
2520338	GED0112732S	27 x 32	370	900
2520311	GED0113032S	30 x 32	370	860
2520303	GED0113034S	30 x 34	430	850
2520281	GED0113036S	30 x 36	430	1300
2520265	GED0113234S	32 x 34	430	1300
2520257	GED0113236S	32 x 36	430	1300
2520249	GED0113436S	34 x 36	430	1250
2520230	GED0113538S	35 x 38	450	1400
2520222	GED0113638S	36 x 38	450	1450
2520214	GED0113641S	36 x 41	450	1450
2520206	GED0113842S	38 x 42	450	1450
2520192	GED0114146S	41 x 46	460	1800
2520184	GED0114650S	46 x 50	480	2100
2520176	GED0115055S	50 x 55	540	3000
2520141	GED0115060S	50 x 60	540	2800
2520133	GED0115560S	55 x 60	540	2800
2520125	GED0116065S	60 x 65	690	4200
2520117	GED0116570S	65 x 70	690	4200
2520109	GED0117080S	70 x 80	770	6000
2520087	GED0117580S	75 x 80	790	6600
2520079	GED0118590S	85 x 90	800	7000



GED011

DOPPELRINGSCHLÜSSEL-SATZ GEKRÖPFT, 12-TEILIG

- ▣ In praxisgerechter Zusammenstellung



 mm

Code	No.	Inhalt	
2516454	GED0110000S	6x7 8x9 10x11 12x13 14x15 16x17 18x19 20x22 21x23 24x27 25x28 30x32	4100

GED011

DOPPELRINGSCHLÜSSEL GEKRÖPFT ZOLL

- ▣ Gekröpft, 12-kant
- ▣ Spezialist für extrem tiefliegende bzw. versenkte Muttern



 "AF

Code	No.	Ø "AF"	l mm	l mm	l mm
2510391	GED0117101S	1/4 x 5/16	170		110
2510286	GED0117102S	5/16 x 3/8	170		100
2510162	GED0117103S	3/8 x 7/16	180		135
2510030	GED0117104S	7/16 x 1/2	195		190
2509911	GED0117105S	1/2 x 9/16	195		175
2493306	GED0117113S	1/2 x 19/32	230		240
2509784	GED0117106S	9/16 x 5/8	230		250
2511134	GED0117107S	19/32 x 11/16	230		230
2493438	GED0117108S	5/8 x 11/16	230		240
2516446	GED0117109S	5/8 x 3/4	280		400
2493187	GED0117114S	11/16 x 3/4	280		400
2509903	GED0117115S	11/16 x 25/32	280		380
2493055	GED0117116S	3/4 x 25/32	280		360
2516438	GED0117110S	3/4 x 7/8	280		370
2492946	GED0117117S	13/16 x 7/8	280		380
2508680	GED0117118S	25/32 x 13/16	280		350
2492814	GED0117119S	7/8 x 15/16	300		510
2493969	GED0117120S	7/8 x 1	300		500
2518708	GED0117121S	7/8 x 1.1/16	330		650
2516411	GED0117111S	15/16 x 1	330		670
2516403	GED0117122S	1 x 1.1/8	330		660
2494027	GED0117123S	1.1/16 x 1.1/8	370		1000
2495252	GED0117112S	1.1/16 x 1.1/4	370		900
2492806	GED0117124S	1.1/8 x 1.5/16	370		880
2515644	GED0117125S	1.3/16 x 1.5/16	430		850
2491583	GED0117126S	1.1/4 x 1.5/16	430		1200
2507455	GED0117127S	1.1/4 x 1.3/8	430		1300
2522969	GED0117128S	1.1/4 x 1.7/16	430		1300
2521733	GED0117129S	1.5/16 x 1.1/2	430		1200
2506246	GED0117130S	1.3/8 x 1.1/2	450		1400
2520524	GED0117131S	1.7/16 x 1.5/8	450		1450
2503794	GED0117132S	1.5/8 x 1.13/16	460		1800
2491575	GED0117133S	1.11/16 x 1.7/8	460		1800
2492687	GED0117134S	1.13/16 x 2	480		2100
2519291	GED0117135S	1.3/4 x 2.1/16	480		2000
2509660	GED0117136S	2 x 2.3/16	540		3000
2516381	GED0117137S	2 x 2.3/8	540		2800
2518082	GED0117138S	2.3/16 x 2.3/8	540		2800
2516853	GED0117139S	2.1/4 x 2.7/16	540		2700

GED011

DOPPELRINGSCHLÜSSEL-SATZ GEKRÖPFT ZOLL, 8-TEILIG

- ▣ In praxiserrechter Zusammenstellung



 "AF

Code	No.	Inhalt	l mm
2520095	GED0117100S	1/4x5/16 3/8x7/16 7/16x1/2 1/2x9/16 9/16x5/8 5/8x11/16 3/4x7/8 15/16x1AF	2100

GED012

DOPPELRINGSCHLÜSSEL GERADE

- ▣ Flache Ausführung, 12-kant



 mm

Code	No.	Ø mm	l mm	l mm	l mm
2501155	GED0120607S	6 x 7	100		12
2501147	GED0120809S	8 x 9	115		16
2497514	GED0120810S	8 x 10	120		20
2497506	GED0120911S	9 x 11	125		22
2493950	GED0121011S	10 x 11	130		24
2493942	GED0121013S	10 x 13	130		24
2493934	GED0121213S	12 x 13	140		40
2493926	GED0121214S	12 x 14	140		45
2493896	GED0121314S	13 x 14	140		45
2493888	GED0121315S	13 x 15	140		45
2493861	GED0121317S	13 x 17	155		50
2493853	GED0121415S	14 x 15	155		48
2493845	GED0121417S	14 x 17	155		50
2493837	GED0121617S	16 x 17	170		70
2493829	GED0121618S	16 x 18	170		65
2493810	GED0121719S	17 x 19	190		80
2493802	GED0121819S	18 x 19	190		80
2493799	GED0121922S	19 x 22	200		120
2493772	GED0121924S	19 x 24	200		120
2493764	GED0122022S	20 x 22	200		120
2493756	GED0122123S	21 x 23	200		120
2493748	GED0122224S	22 x 24	200		120
2493721	GED0122426S	24 x 26	210		135
2493713	GED0122427S	24 x 27	210		130
2493705	GED0122430S	24 x 30	255		185
2493691	GED0122528S	25 x 28	255		200
2493683	GED0122628S	26 x 28	255		190
2493675	GED0122729S	27 x 29	255		185
2493659	GED0122732S	27 x 32	265		228
2493640	GED0123032S	30 x 32	265		228
2493632	GED0123036S	30 x 36	285		284
2493624	GED0123236S	32 x 36	285		284
2493616	GED0123641S	36 x 41	460		330
2493608	GED0124146S	41 x 46	432		810
2493594	GED0124650S	46 x 50	477		1040



GED012

DOPPELRINGSCHLÜSSEL GERADE ZOLL

▀ Flache Ausführung, 12-kant



 "AF"

Code	No.	Ø "AF"	l-mm	l-zoll
2516365	GED01200015	1/4 x 5/16	100	12
2516357	GED01200025	5/16 x 3/8	115	16
2516349	GED01200035	3/8 x 7/16	125	22
2509539	GED01200045	7/16 x 9/16	140	45
2520060	GED01200055	1/2 x 5/8	155	50
2509415	GED01200065	1/2 x 19/32	140	45
2492555	GED01200075	9/16 x 11/16	155	50
2509296	GED01200085	5/8 x 25/32	190	80
2509172	GED01200095	11/16 x 3/4	190	80
2520052	GED01200105	3/4 x 7/8	200	120
2518589	GED01200115	13/16 x 15/16	200	120
2505010	GED01200125	15/16 x 1.1/16	210	130
2520036	GED01200135	1 x 1.1/8	255	200
2503808	GED01200145	1.3/16 x 1.1/4	265	228

GED009

EINRINGSCHLÜSSEL GERADE



 mm

Code	No.	Ø mm	l-mm	l-zoll
2502038	GED00900145	14	140	130
2502011	GED00900155	15	140	130
2502003	GED00900165	16	155	150
2501996	GED00900175	17	155	150
2501988	GED00900185	18	170	250
2501961	GED00900195	19	170	280
2501945	GED00900205	20	190	280
2501937	GED00900215	21	190	300
2501929	GED00900225	22	190	300
2501910	GED00900235	23	215	300
2501902	GED00900245	24	215	400
2501899	GED00900255	25	230	430
2501880	GED00900265	26	230	450
2501872	GED00900275	27	230	500
2501864	GED00900285	28	265	520
2501856	GED00900295	29	265	510
2501821	GED00900305	30	265	500
2501813	GED00900325	32	265	450
2501805	GED00900335	33	265	430
2501791	GED00900345	34	290	670
2501783	GED00900355	35	290	660
2501775	GED00900365	36	290	650
2501767	GED00900375	37	325	900
2501759	GED00900385	38	325	900
2501740	GED00900415	41	325	900
2501732	GED00900425	42	325	900
2501716	GED00900465	46	365	1100
2501708	GED00900475	47	365	1100
2501694	GED00900505	50	400	1400
2501686	GED00900525	52	430	1800
2501678	GED00900545	54	430	1700
2501651	GED00900555	55	445	1650
2501643	GED00900565	56	465	1800
2501635	GED00900585	58	465	1800

Code	No.	Ø mm	l-mm	l-zoll
2501627	GED00900605	60	465	2000
2501619	GED00900635	63	500	2300
2501597	GED00900655	65	500	2100
2501589	GED00900675	67	500	2000
2501570	GED00900705	70	550	3000
2501562	GED00900715	71	550	2800
2501554	GED00900755	75	620	5000
2501546	GED00900775	77	620	5000
2501538	GED00900805	80	620	4500
2501511	GED00900825	82	620	4300
2501503	GED00900855	85	650	5000
2501481	GED00900885	88	650	4800
2501465	GED00900905	90	650	4200
2501457	GED00900945	94	700	5200
2501449	GED00900955	95	700	5200



GED009

EINRINGSCHLÜSSEL GERADE ZOLL



 "AF"

Code	No.	Ø "AF"	l-mm	l-zoll
2502070	GED00900015	1/2	140	130
2497913	GED00900025	9/16	140	130
2494388	GED00900035	19/32	140	130
2502062	GED00900045	5/8	155	150
2494361	GED00900055	11/16	155	150
2502054	GED00900065	3/4	170	280
2494353	GED00900075	25/32	190	280
2494345	GED00900085	13/16	190	300
2502046	GED00900095	7/8	190	300
2494337	GED00900105	15/16	215	400
2494329	GED00900115	31/32	215	430
2507021	GED00900125	1	230	430
2521148	GED00900135	1.1/16	230	500
2494310	GED00900965	1.1/8	265	520
2521113	GED00900975	1.3/16	265	500
2494302	GED00900985	1.1/4	265	450
2521105	GED00900995	1.5/16	265	430
2494299	GED00901005	1.3/8	290	660
2521091	GED00901015	1.7/16	325	900
2494280	GED00901025	1.1/2	325	900
2521083	GED00901035	1.9/16	325	850
2494264	GED00901045	1.5/8	325	900
2516527	GED00901055	1.11/16	325	850
2494256	GED00901065	1.3/4	365	1200
2516519	GED00901075	1.13/16	365	1100
2494248	GED00901085	1.7/8	365	1100
2507013	GED00901095	2	400	1400
2521075	GED00901105	2.1/16	430	1800
2494221	GED00901115	2.1/8	430	1700
2521067	GED00901125	2.3/16	445	1650
2494213	GED00901135	2.1/4	465	1800
2521059	GED00901145	2.5/16	465	1800
2494205	GED00901155	2.3/8	465	2000
2521040	GED00901165	2.7/16	500	2100
2494191	GED00901175	2.1/2	500	2000
2521032	GED00901185	2.9/16	500	2100
2494183	GED00901195	2.3/4	550	3000
2516497	GED00901205	2.15/16	620	5000
2507005	GED00901215	3	620	5000
2494175	GED00901225	3.1/8	620	4500
2494167	GED00901235	3.3/8	650	5000
2494140	GED00901245	3.1/2	650	4800
2494132	GED00901255	3.3/4	700	5200

SCHLAGSCHLÜSSEL FUNKENFREI

GED003

SCHLAG-MAULSCHLÜSSEL

► Für besonders schwere Montagen



 mm

Code	No.	Ø mm	l mm	l mm
2505312	GED00300145	14	180	350
2505304	GED00300175	17	125	120
2505290	GED00300195	19	120	125
2505282	GED00300225	22	135	150
2505266	GED00300245	24	150	200
2505258	GED00300275	27	180	380
2505231	GED00300285	28	180	370
2505223	GED00300295	29	190	360
2505215	GED00300305	30	190	350
2505207	GED00300325	32	210	680
2505193	GED00300335	33	210	670
2505185	GED00300345	34	210	660
2505177	GED00300355	35	210	650
2505169	GED00300365	36	210	640
2505142	GED00300385	38	210	630
2505134	GED00300415	41	220	790
2505126	GED00300425	42	220	750
2505118	GED00300465	46	250	1150
2505096	GED00300475	47	255	1200
2505088	GED00300505	50	275	1350
2505061	GED00300525	52	275	1500
2505053	GED00300545	54	300	1900
2505045	GED00300555	55	290	1600
2505037	GED00300565	56	290	1550
2505002	GED00300585	58	290	1500
2504995	GED00300605	60	320	2600
2504987	GED00300635	63	330	3000
2504979	GED00300655	65	330	3000
2504960	GED00300675	67	380	4200
2504952	GED00300705	70	380	3800
2504944	GED00300715	71	380	3700
2504936	GED00300755	75	380	3600
2504928	GED00300775	77	380	5000
2504901	GED00300805	80	370	4800
2504871	GED00300825	82	370	4700
2504863	GED00300855	85	370	4500
2504855	GED00300885	88	430	7200
2504847	GED00300905	90	430	7000
2504839	GED00300945	94	430	6900
2504820	GED00300955	95	430	6800
2502364	GED00301005	100	470	9500
2502356	GED00301055	105	470	9300
2502348	GED00301105	110	510	14100
2502321	GED00301155	115	510	13300
2502305	GED00301205	120	545	16400
2502291	GED00301255	125	545	15500
2502283	GED00301305	130	575	19800
2502275	GED00301355	135	575	19200
2502267	GED00301405	140	575	19000
2502259	GED00301455	145	640	27000
2502240	GED00301505	150	640	26800
2502232	GED00301555	155	640	26500

Code	No.	Ø mm	l mm	l mm
2502224	GED00301605	160	640	26300
2502216	GED00301655	165	715	39500
2502194	GED00301705	170	715	38500
2502186	GED00301755	175	715	37000
2502178	GED00301805	180	715	36000
2502151	GED00301855	185	715	35800
2502143	GED00301905	190	715	38500
2502135	GED00301955	195	715	38500
2502127	GED00302005	200	715	38000
2502119	GED00302055	205	715	37500
2502100	GED00302105	210	715	37000
2502410	GED00202205	220	715	36500
2502097	GED00302305	230	715	36500

GED003

SCHLAG-MAULSCHLÜSSEL ZOLL

► Für besonders schwere Montagen



 "AF

Code	No.	Ø "AF	l mm	l mm
2509237	GED00300015	1	150	200
2494507	GED00300025	1.1/16	180	380
2498197	GED00300035	1.1/8	180	370
2494493	GED00300045	1.3/16	190	350
2498170	GED00300055	1.1/4	210	680
2494485	GED00300065	1.5/16	210	670
2498162	GED00300075	1.3/8	210	650
2494477	GED00300085	1.7/16	210	640
2498154	GED00300095	1.1/2	210	630
2494418	GED00302525	1.9/16	220	750
2498146	GED00300105	1.5/8	220	790
2521180	GED00300115	1.11/16	220	750
2498138	GED00300125	1.3/4	250	1100
2521172	GED00300135	1.13/16	250	1150
2498111	GED00302315	1.7/8	255	1200
2509229	GED00302325	2	275	1350
2494469	GED00302335	2.1/16	275	1500
2498103	GED00302345	2.1/8	300	1900
2494450	GED00302355	2.3/16	290	1600
2498081	GED00302365	2.1/4	290	1500
2494442	GED00302375	2.5/16	290	1500
2497964	GED00302535	2.3/8	320	2600
2494434	GED00302385	2.7/16	330	3000
2497956	GED00302545	2.1/2	330	3000
2494426	GED00302395	2.9/16	330	3000
2498073	GED00302405	2.5/8	380	4200
2498065	GED00302415	2.3/4	380	3800
2521164	GED00302555	2.13/16	380	3700
2521156	GED00302565	2.15/16	380	3500
2509210	GED00302425	3	380	4000
2498049	GED00302435	3.1/8	370	4800
2498030	GED00302445	3.1/4	370	4700
2498022	GED00302455	3.3/8	370	4500
2498014	GED00302465	3.1/2	430	7200
2498006	GED00302475	3.5/8	430	7000
2497999	GED00302485	3.3/4	430	6800
2497921	GED00302575	3.7/8	430	6600
2509202	GED00302495	4	470	9500
2497980	GED00302505	4.1/8	470	9500
2497972	GED00302515	4.1/2	510	13300

GED010

SCHLAG-RINGSCHLÜSSEL

► Für besonders schwere Montagen



mm

Code	No.	Ø mm	l mm	l mm
2504812	GED01000175	17	150	400
2504804	GED01000195	19	150	400
2504790	GED01000225	22	150	350
2504782	GED01000245	24	150	350
2504766	GED01000275	27	190	600
2504758	GED01000285	28	190	580
2504731	GED01000295	29	190	560
2504723	GED01000305	30	190	550
2504715	GED01000325	32	190	580
2504707	GED01000335	33	190	570
2504693	GED01000345	34	210	680
2504685	GED01000355	35	210	700
2504677	GED01000365	36	210	690
2504669	GED01000375	37	210	680
2504642	GED01000385	38	230	1100
2504634	GED01000415	41	230	1000
2504626	GED01000425	42	230	1000
2504618	GED01000465	46	240	1250
2504596	GED01000475	47	240	1270
2504588	GED01000505	50	255	1400
2504561	GED01000525	52	255	1400
2504553	GED01000545	54	255	1350
2504545	GED01000555	55	255	1340
2504537	GED01000565	56	255	1330
2504510	GED01000575	57	255	1300
2504502	GED01000585	58	280	2500
2504499	GED01000605	60	280	2400
2504480	GED01000635	63	295	2900
2504472	GED01000655	65	295	2800
2504464	GED01000675	67	295	2700
2504456	GED01000705	70	320	3400
2504448	GED01000715	71	320	3300
2504421	GED01000755	75	320	3200
2504413	GED01000765	76	320	3100
2504391	GED01000775	77	320	3000
2504383	GED01000805	80	355	3600
2504375	GED01000825	82	355	3500
2504367	GED01000855	85	365	5000
2504359	GED01000885	88	360	4800
2504340	GED01000905	90	360	4600
2504332	GED01000945	94	360	4500
2504324	GED01000955	95	360	4400
2501430	GED01001005	100	360	4200
2501422	GED01001055	105	360	3900
2501414	GED01001105	110	450	8600
2501406	GED01001155	115	450	8100
2501392	GED01001205	120	480	9700
2501384	GED01001255	125	480	9500
2501376	GED01001285	128	520	13200
2501333	GED01001305	130	520	13200
2501325	GED01001355	135	520	12900
2501317	GED01001405	140	520	12900
2501309	GED01001455	145	580	19000
2501295	GED01001505	150	580	18000
2501287	GED01001555	155	580	17200
2501279	GED01001605	160	580	19000
2501260	GED01001655	165	650	28000

Code	No.	Ø mm	l mm	l mm
2501252	GED01001705	170	650	27700
2501244	GED01001755	175	650	27000
2501228	GED01001805	180	650	26000
2501201	GED01001855	185	700	32700
2501198	GED01001905	190	700	32200
2501171	GED01001955	195	700	31800
2501163	GED01002005	200	700	31000



GED010

SCHLAG-RINGSCHLÜSSEL ZOLL

► Für besonders schwere Montagen



"AF

Code	No.	Ø "AF	l mm	l mm
2497883	GED01002015	11/16	150	400
2504316	GED01002025	3/4	150	400
2497875	GED01002035	25/32	150	390
2497867	GED01002045	13/16	150	380
2504308	GED01002055	7/8	150	350
2497859	GED01002065	15/16	150	350
2509199	GED01002075	1	150	340
2494094	GED01002085	1.1/16	190	700
2497840	GED01002095	1.1/8	190	580
2497832	GED01002105	1.1/4	190	580
2494086	GED01002115	1.3/16	190	550
2494124	GED01000065	1.5/16	190	570
2497816	GED01002125	1.3/8	210	700
2494116	GED01000085	1.7/16	210	690
2497905	GED01000095	1.1/2	230	1100
2494108	GED01000105	1.9/16	230	1000
2497808	GED01002135	1.5/8	230	1000
2521024	GED01002145	1.11/16	230	1000
2497891	GED01000135	1.3/4	240	1200
2521008	GED01002155	1.13/16	240	1250
2497794	GED01002165	1.7/8	240	1270
2509180	GED01002175	2	255	1400
2494043	GED01002335	2.1/16	255	1400
2497786	GED01002185	2.1/8	255	1350
2494078	GED01002195	2.3/16	255	1340
2497778	GED01002205	2.1/4	255	1300
2494019	GED01002345	2.5/16	280	2500
2497751	GED01002215	2.3/8	280	2400
2494000	GED01002355	2.7/16	295	2700
2497662	GED01002365	2.1/2	295	2900
2494051	GED01002225	2.9/16	295	2800
2497743	GED01002235	2.5/8	295	2700
2497735	GED01002245	2.3/4	320	3200
2520982	GED01002375	2.13/16	320	3300
2497727	GED01002255	2.7/8	320	3300
2520990	GED01002265	2.15/16	320	3200
2509164	GED01002275	3	320	3100
2497719	GED01002305	3.1/8	355	3600
2497654	GED01002385	3.1/4	355	3500
2497646	GED01002395	3.3/8	365	5000
2497638	GED01002405	3.1/2	360	4800
2497611	GED01002415	3.5/8	360	4500
2497689	GED01002315	3.3/4	360	4500
2497670	GED01002325	3.7/8	360	4300
2509156	GED01002425	4	360	4200
2497603	GED01002435	4.1/8	360	3900
2497581	GED01002445	4.1/2	450	8100

GED010

SCHLAG-RINGSCHLÜSSEL GEKRÖPFT

► Für besonders schwere Montagen



 mm

Code	No.	Ø mm	l mm	l mm	l mm
2520974	GED0100250S	27	245	1100	
2520966	GED0100251S	30	270	1500	
2520958	GED0100252S	32	270	1500	
2520931	GED0100253S	36	280	1600	
2520923	GED0100254S	41	310	2100	
2520915	GED0100255S	46	320	2500	
2520907	GED0100256S	50	320	2500	
2520885	GED0100257S	55	320	2600	
2520877	GED0100258S	60	355	3200	
2520869	GED0100259S	65	380	3800	
2520850	GED0100260S	70	400	4600	
2520842	GED0100261S	75	420	5700	
2520834	GED0100262S	80	440	6600	
2520826	GED0100263S	85	440	7000	
2520818	GED0100264S	90	440	9300	
2520796	GED0100265S	95	440	10000	
2516489	GED0100266S	100	440	11700	
2516470	GED0100267S	110	440	13400	
2516462	GED0100268S	115	440	14500	

GED031

ZUGMAULSCHLÜSSEL

► Maulstellung wahlweise 90°, 45° oder 15°



 mm

Code	No.	Grad	Ø mm	l mm	l mm
2519208	GED0310022S-15	15	22	320	450
2519151	GED0310023S-15	15	23	320	450
2519127	GED0310024S-15	15	24	350	600
2519097	GED0310025S-15	15	25	350	600
2519054	GED0310026S-15	15	26	380	850
2519011	GED0310027S-15	15	27	380	850
2518988	GED0310028S-15	15	28	420	1000
2520028	GED0310029S-15	45	29	420	1000
2518945	GED0310030S-15	15	30	420	1000
2518902	GED0310032S-15	15	32	450	1000
2518872	GED0310033S-15	15	33	450	1000
2518848	GED0310034S-15	15	34	450	1000
2518791	GED0310035S-15	15	35	500	1400
2518767	GED0310036S-15	15	36	500	1400
2518732	GED0310037S-15	15	37	500	1400
2518694	GED0310038S-15	15	38	500	1400
2518651	GED0310041S-15	15	41	550	1800
2518627	GED0310042S-15	15	42	550	1800
2518597	GED0310046S-15	15	46	600	2500
2518554	GED0310047S-15	15	47	600	2500
2518511	GED0310050S-15	15	50	660	3200
2518473	GED0310052S-15	15	52	660	3200
2518430	GED0310054S-15	15	54	660	4400
2518406	GED0310055S-15	15	55	730	4400
2518376	GED0310056S-15	15	56	730	4400
2518325	GED0310058S-15	15	58	800	5600
2518295	GED0310060S-15	15	60	800	5600



Code	No.	Grad	Ø mm	l mm	l mm
2519194	GED0310022S-45	45	22	320	450
2519143	GED0310023S-45	45	23	320	450
2519119	GED0310024S-45	45	24	350	600
2519089	GED0310025S-45	45	25	350	600
2519046	GED0310026S-45	45	26	380	850
2519003	GED0310027S-45	45	27	380	850
2518961	GED0310028S-45	45	28	420	1000
2520001	GED0310029S-45	45	29	420	1000
2518929	GED0310030S-45	45	30	420	1000
2518899	GED0310032S-45	45	32	450	1000
2518864	GED0310033S-45	45	33	450	1000
2518821	GED0310034S-45	45	34	450	1000
2518783	GED0310035S-45	45	35	500	1400
2518759	GED0310036S-45	45	36	500	1400
2518724	GED0310037S-45	45	37	500	1400
2518686	GED0310038S-45	45	38	500	1400
2518643	GED0310041S-45	45	41	550	1800
2518619	GED0310042S-45	45	42	550	1800
2518570	GED0310046S-45	45	46	600	2500
2518546	GED0310047S-45	45	47	600	2500
2518503	GED0310050S-45	45	50	660	3200
2518465	GED0310052S-45	45	52	660	3200
2518422	GED0310054S-45	45	54	660	4400
2518392	GED0310055S-45	45	55	730	4400
2518368	GED0310056S-45	45	56	730	4400
2518317	GED0310058S-45	45	58	800	5600
2518287	GED0310060S-45	45	60	800	5600

Code	No.	Grad	Ø mm	l mm	l mm
2519178	GED0310022S-90	90	22	320	450
2519135	GED0310023S-90	90	23	320	450
2519100	GED0310024S-90	90	24	350	600
2519070	GED0310025S-90	90	25	350	600
2519038	GED0310026S-90	90	26	380	850
2518996	GED0310027S-90	90	27	380	850
2518953	GED0310028S-90	90	28	420	1000
2519992	GED0310029S-90	90	29	420	1000
2518910	GED0310030S-90	90	30	420	1000
2518880	GED0310032S-90	90	32	450	1000
2518856	GED0310033S-90	90	33	450	1000
2518805	GED0310034S-90	90	34	450	1000
2518775	GED0310035S-90	90	35	500	1400
2518740	GED0310036S-90	90	36	500	1400
2518716	GED0310037S-90	90	37	500	1400
2518678	GED0310038S-90	90	38	500	1400
2518635	GED0310041S-90	90	41	550	1800
2518600	GED0310042S-90	90	42	550	1800
2518562	GED0310046S-90	90	46	600	2500
2518538	GED0310047S-90	90	47	600	2500
2518481	GED0310050S-90	90	50	660	3200
2518449	GED0310052S-90	90	52	660	3200
2518414	GED0310054S-90	90	54	660	4400
2518384	GED0310055S-90	90	55	730	4400
2518341	GED0310056S-90	90	56	730	4400
2518309	GED0310058S-90	90	58	800	5600
2518279	GED0310060S-90	90	60	800	5600

GED031

ZUGMAULSCHLÜSSEL ZOLL

▀ Maulstellung wahlweise 90°, 45° oder 15°



Code	No.	Grad	Ø ^{AF}	↳mm↳	↕
2492431	GED03100015-15	15	13/16	320	450
2516098	GED03100025-15	15	7/8	320	450
2492075	GED03100035-15	15	15/16	350	600
2491710	GED03100045-15	15	31/32	350	600
2492296	GED03100055-15	15	1	350	600
2518333	GED03100065-15	15	1.1/16	380	850
2523930	GED03100075-15	15	1.1/8	420	1000
2517957	GED03100085-15	15	1.3/16	450	1000
2523574	GED03100095-15	15	1.1/4	450	1000
2517590	GED03100105-15	15	1.5/16	450	1000
2523205	GED03100115-15	15	1.3/8	500	1400
2517221	GED03100125-15	15	1.7/16	500	1400
2522837	GED03100135-15	15	1.1/2	500	1400
2516861	GED03100145-15	15	1.9/16	550	1800
2522489	GED03100155-15	15	1.5/8	550	1800
2502569	GED03100165-15	15	1.11/16	550	1800
2522128	GED03100175-15	15	1.3/4	600	2500
2498901	GED03100185-15	15	1.13/16	600	2500
2521741	GED03100195-15	15	1.7/8	600	2500
2492253	GED03100205-15	15	2	660	3200
2516500	GED03100215-15	15	2.1/16	660	3200
2521377	GED03100615-15	15	2.1/8	660	4400
2516144	GED03100625-15	15	2.3/16	730	4400
2521016	GED03100635-15	15	2.1/4	800	4400
2515776	GED03100645-15	15	2.5/16	800	5600
2520656	GED03100655-15	15	2.3/8	800	5600

Code	No.	Grad	Ø ^{AF}	↳mm↳	↕
2492326	GED03100015-45	45	13/16	320	450
2516071	GED03100025-45	45	7/8	320	450
2491966	GED03100035-45	45	15/16	350	600
2491591	GED03100045-45	45	31/32	350	600
2492288	GED03100055-45	45	1	350	600
2518228	GED03100065-45	45	1.1/16	380	850
2523817	GED03100075-45	45	1.1/8	420	1000
2517833	GED03100085-45	45	1.3/16	450	1000
2523450	GED03100095-45	45	1.1/4	450	1000
2517477	GED03100105-45	45	1.5/16	450	1000
2523094	GED03100115-45	45	1.3/8	500	1400
2517116	GED03100125-45	45	1.7/16	500	1400
2522713	GED03100135-45	45	1.1/2	500	1400
2516748	GED03100145-45	45	1.9/16	550	1800
2522357	GED03100155-45	45	1.5/8	550	1800
2501341	GED03100165-45	45	1.11/16	550	1800
2521997	GED03100175-45	45	1.3/4	600	2500
2497697	GED03100185-45	45	1.13/16	600	2500
2521628	GED03100195-45	45	1.7/8	600	2500
2492245	GED03100205-45	45	2	660	3200
2516373	GED03100215-45	45	2.1/16	660	3200
2521245	GED03100615-45	45	2.1/8	660	4400
2516012	GED03100625-45	45	2.3/16	730	4400
2520893	GED03100635-45	45	2.1/4	800	4400
2515652	GED03100645-45	45	2.5/16	800	5600
2520532	GED03100655-45	45	2.3/8	800	5600

Code	No.	Grad	Ø ^{AF}	↳mm↳	↕
2492199	GED03100015-90	90	13/16	320	450
2516063	GED03100025-90	90	7/8	320	450
2491842	GED03100035-90	90	15/16	350	600
2524066	GED03100045-90	90	31/32	350	600
2492261	GED03100055-90	90	1	350	600
2518090	GED03100065-90	90	1.1/16	380	850
2523698	GED03100075-90	90	1.1/8	420	1000
2517728	GED03100085-90	90	1.3/16	450	1000
2523329	GED03100095-90	90	1.1/4	450	1000
2517345	GED03100105-90	90	1.5/16	450	1000
2522977	GED03100115-90	90	1.3/8	500	1400
2516993	GED03100125-90	90	1.7/16	500	1400
2522608	GED03100135-90	90	1.1/2	500	1400
2516624	GED03100145-90	90	1.9/16	550	1800
2522233	GED03100155-90	90	1.5/8	550	1800
2500124	GED03100165-90	90	1.11/16	550	1800
2521865	GED03100175-90	90	1.3/4	600	2500
2496453	GED03100185-90	90	1.13/16	600	2500
2521490	GED03100195-90	90	1.7/8	600	2500
2492237	GED03100205-90	90	2	660	3200
2516268	GED03100215-90	90	2.1/16	660	3200
2521121	GED03100615-90	90	2.1/8	660	4400
2515881	GED03100625-90	90	2.3/16	730	4400
2520761	GED03100635-90	90	2.1/4	800	4400
2514796	GED03100645-90	90	2.5/16	800	5600
2520400	GED03100655-90	90	2.3/8	800	5600



GED027

ZUGRINGSCHLÜSSEL

▀ Gekröpft, 12-kant



 mm

Code	No.	Ø mm	l mm	l ₂ mm
2510790	GED0270025S	22	260	960
2510804	GED0270024S	24	260	1000
2510782	GED0270027S	27	260	960
2510774	GED0270030S	30	260	950
2510758	GED0270032S	32	260	940
2510731	GED0270033S	33	260	920
2510723	GED0270034S	34	260	910
2510715	GED0270035S	35	260	910
2510707	GED0270036S	36	260	910
2510693	GED0270037S	37	270	1200
2510685	GED0270038S	38	270	1900
2510677	GED0270041S	41	270	1100
2510669	GED0270042S	42	270	1100
2510650	GED0270046S	46	300	1500
2510634	GED0270047S	47	300	1500
2510626	GED0270050S	50	300	1700
2510618	GED0270052S	52	350	2600
2510596	GED0270054S	54	350	2500
2510588	GED0270055S	55	300	1900
2510561	GED0270056S	56	350	2600
2510553	GED0270058S	58	350	2500
2510545	GED0270060S	60	370	2500
2510537	GED0270063S	63	370	2500
2510529	GED0270065S	65	400	3200
2510502	GED0270067S	67	400	3100
2510499	GED0270070S	70	400	3000
2510480	GED0270071S	71	400	2800
2510472	GED0270075S	75	400	2700
2510464	GED0270077S	77	400	2600
2510456	GED0270080S	80	410	5000
2510448	GED0270082S	82	410	5000
2510421	GED0270085S	85	410	5100
2510413	GED0270090S	90	410	5010
2510405	GED0270095S	95	410	4790
2508435	GED0270100S	100	412	4545

GED027

AUFSTECKROHR FÜR ZUGRINGSCHLÜSSEL

▀ Zur Verlängerung des Hebelarms und Aufbringung höherer Kräfte



Code	No.	für SW	Ø	l mm	l ₂ mm
2511967	GED0271001S	22 - 42 mm / 1.3/16 - 1.5/8AF	22	600	1100
2511959	GED0271002S	46 - 58 mm / 1.11/16 - 2.1/4AF	25	750	2800
2510383	GED0271003S	60 - 100 mm / 2.5/16 - 3.3/8AF	30	850	3800

GED027

ZUGRINGSCHLÜSSEL ZOLL

▀ Gekröpft, 12-kant



 "AF

Code	No.	Ø "AF	l mm	l ₂ mm
2503913	GED0270001S	1.3/16	260	950
2506637	GED0270002S	1.1/4	260	940
2503905	GED0270003S	1.5/16	260	920
2506629	GED0270004S	1.3/8	260	910
2503891	GED0270005S	1.7/16	260	910
2506610	GED0270006S	1.1/2	270	1900
2503883	GED0270007S	1.9/16	270	1200
2506599	GED0270008S	1.5/8	270	1100
2499673	GED0270009S	1.11/16	270	1100
2506580	GED0270010S	1.3/4	270	1000
2499665	GED0270011S	1.13/16	300	1500
2506572	GED0270012S	1.7/8	300	1500
2513021	GED0270013S	2	300	1700
2503875	GED0270014S	2.1/16	350	2600
2506564	GED0270015S	2.1/8	350	2400
2503867	GED0270016S	2.3/16	300	1900
2506556	GED0270017S	2.1/4	350	2500
2503859	GED0270018S	2.5/16	350	2500
2506548	GED0270019S	2.3/8	370	2500
2503840	GED0270020S	2.7/16	370	2500
2506521	GED0270021S	2.1/2	370	2500
2503832	GED0270022S	2.9/16	400	3200
2506513	GED0270023S	2.5/8	400	3100
2506505	GED0270104S	2.3/4	400	3000
2499657	GED0270105S	2.13/16	400	2800
2499630	GED0270106S	2.15/16	400	2700
2513013	GED0270107S	3	400	2500
2506491	GED0270108S	3.1/8	410	4900
2506475	GED0270109S	3.1/4	410	5000
2506467	GED0270110S	3.3/8	410	5100

GED027

ZUGRINGSCHLÜSSEL-SATZ, 18-TEILIG

▀ In praxisgerechter Zusammenstellung



 mm

Code	No.	Inhalt	l ₂ mm
2492318	GED0270111S	Schlüssel 24 - 27 - 30 - 32 - 36 41 - 46 - 50 - 55 - 60 65 - 70 - 75 - 80 - 85 Aufsteckrohre 22 - 42 / 46 - 58 / 60 - 100	40200

MONTAGESCHLÜSSEL FUNKENFREI

GED01373

MONTAGEMAULSCHLÜSSEL MIT DORN

► Praktische Kombination von Maulschlüssel und Montagedorn



Code	No.	Ø mm	l mm	l ₁ mm
2501058	GED01373005	17	320	270
2501031	GED01373015	18	320	270
2501023	GED01373025	19	350	465
2501015	GED01373035	20	350	465
2501007	GED01373045	21	350	465
2500981	GED01373055	22	350	465
2500965	GED01373065	23	370	650
2500957	GED01373075	24	370	650
2500949	GED01373085	25	370	650
2500930	GED01373095	26	370	650
2500922	GED01373105	27	370	650
2500914	GED01373115	28	400	950
2500906	GED01373125	29	400	950
2500892	GED01373135	30	400	950
2500884	GED01373145	32	400	950
2500876	GED01373155	33	400	950
2500841	GED01373165	34	400	950
2500833	GED01373175	35	430	1400
2500825	GED01373185	36	430	1400
2500817	GED01373195	37	430	1400
2500809	GED01373205	38	430	1400
2500795	GED01373215	41	470	1900
2500787	GED01373225	42	470	1900
2500779	GED01373235	46	500	2700
2500760	GED01373245	47	500	2700
2500752	GED01373255	50	530	3550

GED01373

MONTAGEMAULSCHLÜSSEL MIT DORN ZOLL

► Praktische Kombination von Maulschlüssel und Montagedorn



Code	No.	Ø AF	l mm	l ₁ mm
2493330	GED01373265	11/16	320	270
2500736	GED01373275	3/4	350	270
2493322	GED01373285	25/32	350	465
2493314	GED01373295	13/16	350	465
2500728	GED01373305	7/8	350	465
2493292	GED01373315	15/16	370	465
2493284	GED01373325	31/32	370	650
2506947	GED01373335	1	370	650
2519984	GED01373345	1.1/16	370	650
2493276	GED01373355	1.1/8	400	650
2519976	GED01373365	1.3/16	400	650
2493268	GED01373375	1.1/4	400	950
2519968	GED01373385	1.5/16	400	950
2493241	GED01373395	1.3/8	430	950
2519941	GED01373405	1.7/16	430	1400
2493233	GED01373415	1.1/2	430	1400
2519933	GED01373425	1.9/16	470	1400
2493225	GED01373435	1.5/8	470	1900
2516330	GED01373445	1.11/16	470	1900
2493217	GED01373455	1.3/4	500	1900
2516322	GED01373465	1.13/16	500	2700
2493209	GED01373475	1.7/8	500	2700
2506939	GED01373485	2	530	3550

GED01373

MONTAGEMAULSCHLÜSSEL MIT DORN, GEKRÖPFT

► Praktische Kombination von gekröpftem Maulschlüssel und Montagedorn



Code	No.	Ø mm	l mm	l ₁ mm
2500701	GED01373495	17	320	295
2500698	GED01373505	18	320	295
2500671	GED01373515	19	350	510
2500663	GED01373525	20	350	510
2500655	GED01373535	21	350	510
2500647	GED01373545	22	350	510
2500639	GED01373555	23	370	715
2500620	GED01373565	24	370	715
2500604	GED01373575	25	370	715
2500590	GED01373585	26	370	715
2500582	GED01373595	27	370	715
2500574	GED01373605	28	400	1145
2500566	GED01373615	29	400	1145

Code	No.	Ø mm	l mm	l ₁ mm
2500558	GED01373625	30	400	1145
2500531	GED01373635	32	400	1145
2500523	GED01373645	33	400	1145
2500515	GED01373655	34	400	1145
2500507	GED01373665	35	430	1540
2500485	GED01373675	36	430	1540
2500477	GED01373685	37	430	1540
2500469	GED01373695	38	430	1540
2500450	GED01373705	41	470	2090
2500442	GED01373715	42	470	2090
2500434	GED01373725	46	500	2970
2500426	GED01373735	47	500	2970
2500418	GED01373745	50	530	3900



GED01373

MONTAGEMAULSCHLÜSSEL MIT DORN ZOLL, GEKRÖPFT

► Praktische Kombination von gekröpftem Maulschlüssel und Montagedor



 "AF

Code	No.	Ø "AF	l mm	l mm
2493195	GED0137375S	11/16	290	295
2500396	GED0137376S	7/8	355	510
2493179	GED0137377S	15/16	355	510
2519925	GED0137378S	1.1/16	380	715
2519909	GED0137379S	1.3/16	410	715
2493160	GED0137380S	1.1/4	380	1145
2519895	GED0137381S	1.7/16	460	1540
2493152	GED0137382S	1.1/2	460	1145
2493144	GED0137383S	1.5/8	510	2090
2516314	GED0137384S	1.13/16	550	2970
2506920	GED0137385S	2	550	3900

GED01375

MONTAGERINGSCHLÜSSEL MIT DORN ZOLL, GEKRÖPFT

► Praktische Kombination von gekröpftem Ringschlüssel und Montagedor
► 12-kant



 "AF

Code	No.	Ø "AF	l mm	l mm
2492970	GED0137526S	11/16	290	295
2500051	GED0137527S	7/8	355	510
2492962	GED0137528S	15/16	355	510
2519690	GED0137529S	1.1/16	380	715
2519682	GED0137530S	1.3/16	410	715
2492954	GED0137531S	1.1/4	380	1145
2519666	GED0137532S	5.7/16	460	1540
2492938	GED0137533S	1.1/2	460	1145
2492911	GED0137534S	1.5/8	510	2090
2516306	GED0137535S	1.13/16	550	2970
2506912	GED0137536S	2	550	3900

GED01375

MONTAGERINGSCHLÜSSEL MIT DORN, GEKRÖPFT

► Praktische Kombination von gekröpftem Ringschlüssel und Montagedor
► 12-kant



 mm

Code	No.	Ø mm	l mm	l mm
2500388	GED0137500S	17	320	295
2500353	GED0137501S	18	320	295
2500345	GED0137502S	19	350	510
2500337	GED0137503S	20	350	510
2500329	GED0137504S	21	350	510
2500310	GED0137505S	22	350	510
2500302	GED0137506S	23	370	715
2500299	GED0137507S	24	370	715
2500280	GED0137508S	25	370	715
2500272	GED0137509S	26	370	715
2500264	GED0137510S	27	370	715
2500248	GED0137511S	28	400	1145
2500221	GED0137512S	29	400	1145
2500213	GED0137513S	30	400	1145
2500205	GED0137514S	32	400	1145
2500191	GED0137515S	33	400	1145
2500183	GED0137516S	34	400	1145
2500175	GED0137517S	35	430	1540
2500167	GED0137518S	36	430	1540
2500159	GED0137519S	37	430	1540
2500140	GED0137520S	38	430	1540
2500116	GED0137521S	41	470	2090
2500108	GED0137522S	42	470	2090
2500094	GED0137523S	46	500	2970
2500086	GED0137524S	47	500	2970
2500078	GED0137525S	50	530	3900

SPEZIALSCHLÜSSEL FUNKENFREI

GED703

KUPPLUNGSSCHLÜSSEL

► Für Feuerwehr- (Storz) Kupplungen A - B - C



Code	No.	Ø	l mm	l mm
2511878	GED7030455S	14	440	800

GED703

KUPPLUNGSSCHLÜSSEL

► Für Feuerwehr- (Storz) Kupplungen B - C
► Griff gegen Kälte kunststoffisoliert



Code	No.	Ø	l mm	l mm
2521954	GED7030285S	12	280	450

GED091

GELENK-HAKENSCHLÜSSEL



Code	No.	Ø	↳mm↳	↕
2496968	GED09111175	32-75	205	230
2517108	GED09132755	50-120	285	450
2515407	GED09150125	115-170	310	500

GED090

HAKENSCHLÜSSEL



Code	No.	Ø	↳mm↳	↕
2506068	GED09012145	12-14	110	30
2506041	GED09016205	16-20	110	30
2506033	GED09025285	25-28	135	50
2506025	GED09030325	30-32	135	50
2506017	GED09034365	34-36	170	100
2506009	GED09040425	40-42	170	100
2505983	GED09045505	45-50	205	190
2505975	GED09052555	52-55	205	190
2505967	GED09058625	58-62	240	215
2505959	GED09068755	68-75	240	200
2505940	GED09080905	80-90	280	410
2503093	GED09095105	95-100	280	410
2499045	GED09097005	110-115	335	730
2499029	GED09098005	120-130	335	730
2499010	GED09099005	135-145	390	1150
2499002	GED09099905	155-165	390	1150
2498995	GED09099915	180-195	465	1410
2498987	GED09099925	205-220	465	1385

GED700

SCHIEBERKLAUE



Code	No.	Größe	↳mm↳	↕
2509458	GED70005005	30 - 40	500	720

GED702

VENTILHAKEN



Code	No.	Ø	Abstand	↳mm↳	↕
2512270	GED70213305	13	30	300	350
2512262	GED70213355	13	35	350	600
2512254	GED70216405	16	40	400	680
2512246	GED70216455	16	45	450	1100
2512211	GED70219505	19	50	500	1200
2512203	GED70222605	22	60	600	2000
2512181	GED70225705	25	70	700	3000
2512173	GED70228805	28	80	800	5300

GED703

STIRNLOCHSCHLÜSSEL



Code	No.	Zapfenabstand	Zapfen Ø	↳mm↳	↕
2505452	GED99910245	35	5	180	150

GED701

HANDRADSCHLÜSSEL

▶ Analog DIN 87311



Code	No.	Ø	↳mm↳	↕
2498707	GED70136605	36 x 60	370	650
2498693	GED70148805	48 x 80	430	2600
2495546	GED70148105	62 x 102	550	1300





GED9991

B-HANDRADSCHLÜSSEL

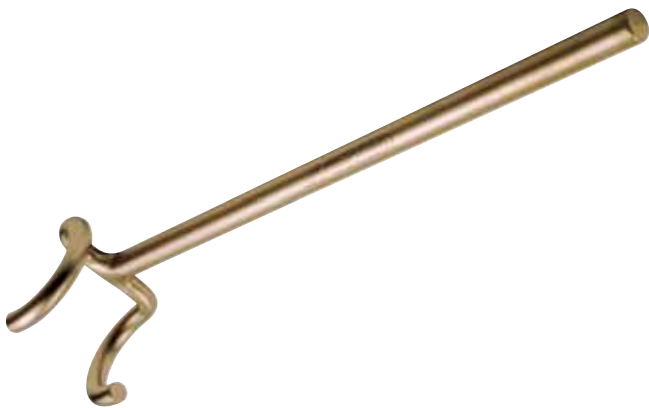

Code	No.	Ø	l mm	l mm
2521520	GED9991010S	36 x 60	330	600
2521512	GED9991011S	48 x 80	470	1400
2521504	GED9991012S	62 x 102	600	2600

GED9991

SCHLÜSSEL FÜR TANKWAGENVENTIL



Code	No.	Ausführung	Zapfen	Außenmaß	Aussparung	Stiel	l mm
2495430	GED9991007S	Typ A	20	160 x 90	64 x 32	500	1800
2495422	GED9991008S	Typ B	20	150 x 90	64 x 32	500	1600
2495414	GED9991009S	Typ C	20	190 x 90	95 x 47,5	500	2500

GED0341

4-KANT-STECKSCHLÜSSEL GEWINKELT



Code	No.	Ø mm	l mm	l mm
2524031	GED0341110S	8	150	90
2524023	GED0341111S	9	160	100
2524015	GED0341112S	10	175	120
2523663	GED0341113S	12	215	220
2523647	GED0341114S	13	230	280
2523639	GED0341115S	14	240	280
2523620	GED0341116S	17	280	330

GED0359

3-KANT-STECKSCHLÜSSELEINSATZ 1/2"



Code	No.	□"	SW	l mm	l mm
2499037	GED0359502S	1/2	M6	40	70
2498928	GED0359503S	1/2	M8	40	75
2498782	GED0359504S	1/2	M10	40	80
2498669	GED0359505S	1/2	M12	40	90
2498537	GED0359506S	1/2	M16	50	150
2498413	GED0359507S	1/2	M20	50	215
2498308	GED0359508S	1/2	M24	60	435

GED0300

3-KANT-STECKSCHLÜSSEL

- ▶ Analog DIN 22417
- ▶ Mit durchgestecktem, beweglichen Quergriff

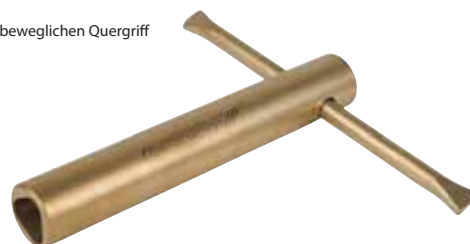

Code	No.	SW	l mm	l mm
2503824	GED0300004S	M4	95	80
2503786	GED0300005S	M5	110	100
2503778	GED0300006S	M6	115	170
2503751	GED0300008S	M8	125	280
2499622	GED0300010S	M10	140	390
2499614	GED0300012S	M12	160	700
2499606	GED0300016S	M16	180	980
2499592	GED0300020S	M20	200	2100
2499584	GED0300024S	M24	220	3100

GED0150

FASSSCHLÜSSEL UNIVERSAL

- ▶ Zum mühelosen Öffnen von festsitzenden Faßverschlüssen



Code	No.	l mm	l mm
2519356	GED0150380S	380	1250

GED0150

UNIVERSALSCHLÜSSEL



Code	No.	l mm	l mm
2504081	GED0150381S	300	600

GED0150

SPEZIAL-UNIVERSALSCHLÜSSEL

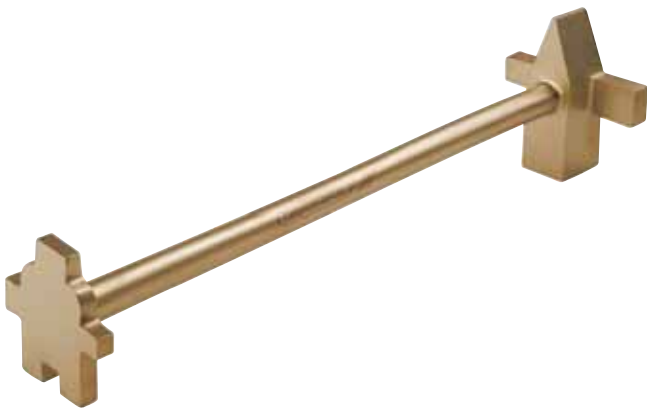

Code	No.	l-mm	Ø
2518457	GED01503825	400	1700

GED7240

KANALDECKELHAKEN



Code	No.	l-mm	Ø
2507498	GED72400035	500	770

GED7240

KANALDECKELHAKEN VERSTÄRKTE AUSFÜHRUNG



Code	No.	l-mm	Ø
2507501	GED72400025	700	1200

GED0251

6-KANT-STECKSCHLÜSSEL



Code	No.	Ø mm	l-mm	Ø
2499703	GED0251055S	8	190	110
2499681	GED0251056S	9	200	135
2497344	GED0251057S	10	215	160
2497328	GED0251058S	11	230	210
2497301	GED0251059S	12	250	260
2497298	GED0251060S	13	265	350
2497271	GED0251061S	14	265	350
2497263	GED0251062S	15	280	400
2497255	GED0251063S	16	280	400
2497247	GED0251064S	17	300	450
2497239	GED0251065S	18	300	450
2497220	GED0251066S	19	325	650
2497212	GED0251067S	20	325	650
2497190	GED0251068S	21	350	830
2497182	GED0251069S	22	350	830
2497174	GED0251070S	23	380	1140
2497166	GED0251071S	24	380	1140
2497158	GED0251072S	25	415	1450
2497131	GED0251073S	26	415	1450
2497123	GED0251074S	27	415	1450
2497115	GED0251075S	28	450	1800
2497107	GED0251076S	29	450	1800
2497093	GED0251077S	30	450	1800
2497077	GED0251078S	32	485	2450
2497069	GED0251079S	33	485	2450
2497050	GED0251080S	34	485	2450
2497042	GED0251081S	35	530	3300
2497034	GED0251082S	36	530	3300
2497026	GED0251083S	37	530	3300
2497018	GED0251084S	38	530	3300
2496992	GED0251085S	41	580	4000
2496984	GED0251086S	42	580	4000
2496976	GED0251087S	46	635	4800
2496941	GED0251088S	47	635	4800
2496933	GED0251089S	50	320	4900
2496925	GED0251090S	52	320	4900
2496917	GED0251091S	54	340	6500
2496909	GED0251092S	55	340	6500
2496895	GED0251093S	56	340	6500
2496887	GED0251094S	58	360	8300
2496879	GED0251095S	60	360	8300
2496860	GED0251096S	63	360	8300
2496852	GED0251097S	65	380	10500
2496836	GED0251098S	67	380	10500
2496828	GED0251099S	70	380	10500
2496801	GED0251100S	71	380	10500
2496798	GED0251101S	75	400	14300
2496771	GED0251102S	77	400	14300
2496763	GED0251103S	80	400	14300
2496755	GED0251104S	82	400	14300
2496747	GED0251105S	85	425	19200
2496739	GED0251106S	88	425	19200
2496720	GED0251107S	90	425	19200
2496704	GED0251108S	94	455	26000
2496690	GED0251109S	95	455	26000
2492369	GED0251110S	100	455	26000

GED0251

DREHSTIFT FÜR 6-KANT-STECKSCHLÜSSEL

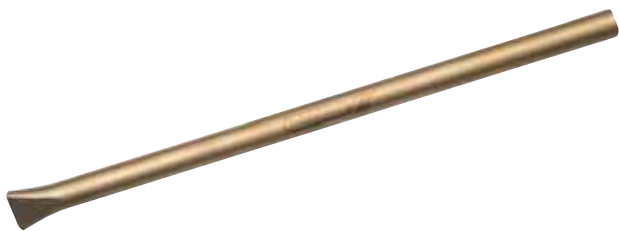

Code	No.	Ø	↳mm←	bis SW mm	↕
2513714	GED0251111S	6	150	10	40
2513692	GED0251112S	8	190	12	75
2512084	GED0251113S	10	190	16	90
2512076	GED0251114S	10	250	22	185
2512068	GED0251115S	12	315	27	310
2512041	GED0251116S	16	400	34	600
2512033	GED0251117S	16	500	38	920
2512025	GED0251118S	20	630	47	1600
2512017	GED0251119S	24	800	63	3100
2512009	GED0251120S	24	1000	63	3850
2511991	GED0251121S	30	1250	82	7500
2511975	GED0251122S	36	1600	100	15000



GED0340

6-KANT-STECKSCHLÜSSEL GEWINKELT



Code	No.	Ø mm	↳mm←	↕
2492229	GED0340008S	8	175	100
2492210	GED0340009S	9	185	120
2492202	GED0340010S	10	195	140
2492180	GED0340011S	11	205	180
2492172	GED0340012S	12	220	220
2492164	GED0340013S	13	240	280
2492156	GED0340014S	14	240	280
2492148	GED0340015S	15	250	300
2492121	GED0340016S	16	250	300
2492113	GED0340017S	17	270	320
2492105	GED0340018S	18	270	320
2492091	GED0340019S	19	290	530
2492083	GED0340020S	20	290	530
2492067	GED0340021S	21	310	680
2492059	GED0340022S	22	310	680
2492040	GED0340023S	23	335	830
2492032	GED0340024S	24	335	830
2492024	GED0340025S	25	365	1000
2492016	GED0340026S	26	365	1000
2492008	GED0340027S	27	365	1000
2491990	GED0340028S	28	395	1300
2491982	GED0340029S	29	395	1300
2491974	GED0340030S	30	395	1300
2491958	GED0340032S	32	425	1700
2491931	GED0340033S	33	425	1700
2491923	GED0340034S	34	425	1700
2491915	GED0340035S	35	465	2800
2491907	GED0340036S	36	465	2800
2491893	GED0340037S	37	465	2800
2491885	GED0340038S	38	465	2800
2491877	GED0340041S	41	510	3600
2491869	GED0340042S	42	510	3600
2491850	GED0340046S	46	555	4000
2491834	GED0340047S	47	555	4000
2491826	GED0340050S	50	605	4800
2491818	GED0340052S	52	605	4800
2491796	GED0340054S	54	660	6400
2491788	GED0340055S	55	660	6400
2491761	GED0340056S	56	660	6400
2491753	GED0340058S	58	730	8200
2491745	GED0340060S	60	730	8200
2491737	GED0340063S	63	730	8200
2491729	GED0340065S	65	800	10400
2491702	GED0340067S	67	800	10400
2491699	GED0340070S	70	800	10400
2491680	GED0340071S	71	800	10400
2491672	GED0340075S	75	880	14100
2491664	GED0340077S	77	880	14100
2491656	GED0340080S	80	880	14100
2491648	GED0340082S	82	880	14100

GED0340

6-KANT-STECKSCHLÜSSEL DOPPELSEITIG
 ▽ Zur Betätigung mit Maulschlüssel oder Drehstift



Code	No.	Ø mm	l mm	SW
2496674	GED0340083S	7 x 8	95	50
2491621	GED0340084S	9 x 10	105	70
2491613	GED0340085S	10 x 11	120	85
2491605	GED0340086S	12 x 14	135	160
2524163	GED0340087S	14 x 17	150	205
2524155	GED0340088S	17 x 19	160	280
2524147	GED0340089S	19 x 22	170	335
2524139	GED0340090S	20 x 22	170	355
2524120	GED0340091S	24 x 26	180	480
2524112	GED0340092S	24 x 27	190	530
2524104	GED0340093S	27 x 32	200	870
2524090	GED0340094S	30 x 32	210	890
2524082	GED0340095S	30 x 36	220	1080
2524074	GED0340096S	36 x 41	230	1700

GED0340

DREHSTIFT FÜR 6-KANT-STECKSCHLÜSSEL



Code	No.	Ø	l mm	bis SW mm	SW
2513005	GED0340097S	5	110	7 x 8	15
2510375	GED0340098S	6	150	10 x 11	40
2508427	GED0340099S	10	220	14 x 17	120
2508419	GED0340100S	12	300	20 x 22	300
2508400	GED0340101S	15	390	24 x 27	480
2508397	GED0340102S	16	500	36 x 41	750



GED0340

6-KANT-STECKSCHLÜSSEL MIT FESTEM QUERGRIF

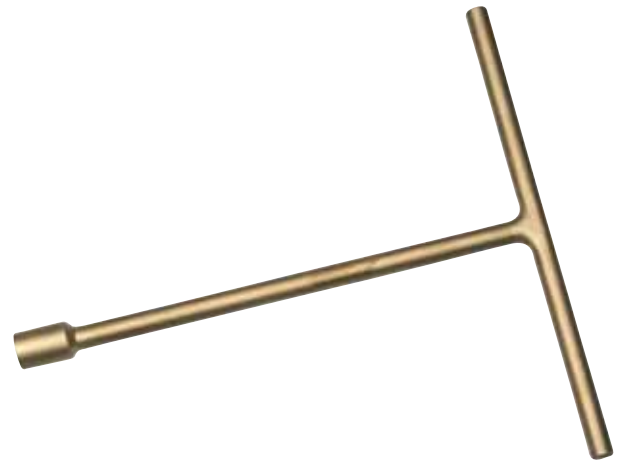

Code	No.	Ø mm	l mm	SW
2516055	GED0340108S	8	196	140
2516047	GED0340109S	9	209	165
2507595	GED0340110S	10	223	190
2507463	GED0340111S	11	240	260
2507331	GED0340112S	12	256	310
2507226	GED0340113S	13	275	410
2507099	GED0340114S	14	275	410
2506963	GED0340115S	15	292	455
2506858	GED0340116S	16	292	455
2506734	GED0340117S	17	314	555
2506602	GED0340118S	18	314	555
2506483	GED0340119S	19	339	785
2506378	GED0340120S	20	339	785
2506254	GED0340121S	21	376	1050
2506114	GED0340122S	22	376	1050
2505991	GED0340123S	23	393	1240
2505886	GED0340124S	24	393	1240
2505762	GED0340125S	25	431	1700
2505630	GED0340126S	26	431	1700
2505517	GED0340127S	27	431	1700
2505398	GED0340128S	28	464	2100
2505274	GED0340129S	29	464	2100
2505150	GED0340130S	30	464	2100
2505029	GED0340132S	32	506	2750
2504898	GED0340133S	33	506	2750
2504774	GED0340134S	34	506	2750
2504650	GED0340135S	35	550	4000
2504529	GED0340136S	36	550	4000
2504405	GED0340137S	37	550	4000
2504294	GED0340138S	38	550	4000
2504170	GED0340141S	41	600	5400
2504049	GED0340142S	42	600	5400
2503921	GED0340146S	46	655	6000
2503816	GED0340147S	47	655	6000
2503670	GED0340150S	50	345	6300
2503549	GED0340152S	52	345	6300
2503425	GED0340154S	54	365	8000
2503301	GED0340155S	55	365	8000
2503182	GED0340156S	56	365	8000
2503069	GED0340158S	58	390	10500
2502933	GED0340160S	60	390	10500
2502828	GED0340163S	63	390	10500
2502690	GED0340165S	65	410	14000
2502577	GED0340167S	67	410	14000
2502437	GED0340170S	70	410	14000
2502313	GED0340171S	71	410	14000
2502208	GED0340175S	75	430	19000
2502089	GED0340177S	77	430	19000
2501953	GED0340180S	80	430	19000
2501848	GED0340182S	82	430	19000

GED0341

STECKSCHLÜSSEL MIT GRIF



 mm

Code	No.	Ø mm	l mm	SW
2496666	GED0341035C	3,5	175	55
2496658	GED0341045C	4,5	180	55
2503735	GED0341050C	5	180	60
2496631	GED0341055C	5,5	185	60
2503727	GED0341060C	6	190	65
2496623	GED0341065C	6,5	190	65
2503719	GED0341070C	7	190	80
2496615	GED0341075C	7,5	200	80
2503700	GED0341080C	8	200	100
2503697	GED0341090C	9	210	100
2499568	GED0341010C	10	210	115
2499541	GED0341011C	11	220	115
2499533	GED0341012C	12	220	130
2499517	GED0341013C	13	230	170
2499509	GED0341014C	14	230	210
2499495	GED0341015S	15	240	210
2499487	GED0341016S	16	240	235
2499479	GED0341017S	17	250	235

GED0341

STECKSCHLÜSSEL MIT GRIF ZOLL



 "AF

Code	No.	Ø "AF	l mm	SW
2499460	GED0341091C	1/8	175	55
2496607	GED0341092C	5/32	180	55
2496585	GED0341093C	3/16	185	60
2496577	GED0341094C	7/32	190	65
2499452	GED0341095C	1/4	190	80
2496569	GED0341096C	5/16	210	100
2499444	GED0341097C	3/8	220	115
2496550	GED0341098C	7/16	230	170
2499436	GED0341099C	1/2	230	210
2496542	GED0341100S	9/16	240	235
2499428	GED0341101S	5/8	250	235
2524058	GED0341102S	11/16	250	240

GED01376

KLAUENSCHLÜSSEL OHNE DREHSTIFT

▀ Abgewinkelter Maulschlüssel für Arbeiten an schwer zugänglichen Stellen



Code	No.	Ø mm	l mm	SW
2500043	GED0137600S	13	160	100
2500035	GED0137601S	14	160	100
2499576	GED0137602S	15	200	170
2500027	GED0137603S	16	200	170
2500019	GED0137604S	17	200	170
2499991	GED0137605S	18	200	190
2499983	GED0137606S	19	200	220
2499975	GED0137607S	20	200	250
2499967	GED0137608S	21	200	260
2499959	GED0137609S	22	200	300
2499940	GED0137610S	23	200	350
2499932	GED0137611S	24	250	400
2499924	GED0137612S	25	250	400
2499916	GED0137613S	26	250	450
2499908	GED0137614S	27	250	450
2499886	GED0137615S	28	250	500
2499878	GED0137616S	29	250	550
2499851	GED0137617S	30	250	600
2499843	GED0137618S	32	250	650
2499835	GED0137619S	36	250	700
2499827	GED0137620S	41	315	1150
2499819	GED0137621S	46	315	1230
2499800	GED0137622S	50	315	1500

GED01376

DREHSTIFT FÜR KLAUENSCHLÜSSEL



Code	No.	Ø	l mm	für SW mm	SW
2516292	GED0137623S	8	160	13 - 15	70
2516284	GED0137624S	10	200	16 - 18	130
2516276	GED0137625S	12	200	19 - 22	220
2509059	GED0137626S	14	250	23 - 27	400
2508931	GED0137627S	16	250	28 - 32	600
2508826	GED0137628S	18	315	36 - 41	1000
2508699	GED0137629S	20	315	46 - 50	1600



GED01376

KRÄHENFUSSSCHLÜSSEL, MAULFORM, VIERKANT 1/2"

12,5
1/2



Code	No.	□"	Ø mm	↔ mm	↕ mm
2519658	GED0137630S	1/2	13	50	
2519631	GED0137631S	1/2	14	50	
2519623	GED0137632S	1/2	15	80	
2519615	GED0137633S	1/2	16	80	
2519607	GED0137634S	1/2	17	80	
2519593	GED0137635S	1/2	18	110	
2519585	GED0137636S	1/2	19	120	
2519577	GED0137637S	1/2	20	130	
2519569	GED0137638S	1/2	21	150	
2519542	GED0137639S	1/2	22	170	
2519534	GED0137640S	1/2	23	200	
2519526	GED0137641S	1/2	24	200	
2519518	GED0137642S	1/2	25	220	
2519496	GED0137643S	1/2	26	220	
2519488	GED0137644S	1/2	27	250	
2519461	GED0137645S	1/2	28	270	
2519453	GED0137646S	1/2	29	300	
2519445	GED0137647S	1/2	30	320	
2519437	GED0137648S	1/2	32	350	
2519410	GED0137649S	1/2	36	570	
2519402	GED0137650S	1/2	41	620	
2519399	GED0137651S	1/2	46	750	
2519380	GED0137652S	1/2	50	800	

GED01376

SPEZIALVERLÄNGERUNG FÜR KRÄHENFUSSSCHLÜSSEL 1/2"

12,5
1/2



Code	No.	□"	□"	↔ mm	↕ mm
2519372	GED0137653S	1/2	1/2	150	200
2519364	GED0137654S	1/2	1/2	250	400

GED01374

BAUKNARRE, 6-KANT, MIT ZENTRIERSPITZE



Code	No.	Ø mm	↔ mm	↕ mm
2493136	GED0137400S	17	230	620
2493128	GED0137401S	19	240	650
2493101	GED0137402S	21	250	830
2493098	GED0137403S	22	260	830
2493071	GED0137404S	24	270	1020
2493063	GED0137405S	26	280	1050
2493047	GED0137406S	27	285	1100
2493039	GED0137407S	30	300	1320
2493020	GED0137408S	32	315	1425
2493012	GED0137409S	35	325	1630
2493004	GED0137410S	36	330	1670
2492997	GED0137411S	41	330	1950

GED01374

FREILAUFKNARRE MIT 12-KANT-RING



Code	No.	Ø mm	↔ mm	↕ mm
2492989	GED0137416C	9	150	125
2519860	GED0137402C	11	150	125
2519836	GED0137405C	13	155	160
2519763	GED0137409C	14	155	160
2519887	GED0137400C	17	200	260
2519879	GED0137401C	19	200	260
2519852	GED0137403C	22	220	340
2519844	GED0137404C	24	220	340
2519828	GED0137406C	27	245	560
2519801	GED0137407C	30	280	840
2519771	GED0137408C	32	280	840
2519755	GED0137410C	36	290	1180
2519747	GED0137411C	41	295	1230
2519739	GED0137412C	46	360	2060
2519720	GED0137413C	50	360	2230
2519712	GED0137414C	55	440	2900
2519704	GED0137415C	60	440	2900

KNARRE



NON
SPARKING



Knarre



KNARRE

* funkenfrei



KNARREN, EINSÄTZE, ZUBEHÖR FUNKENFREI

1/4" ANTRIEB

GED035

STECKSCHLÜSSELEINSATZ 1/4" 6-KANT

► Handbetätigt



6,3
1/4"
mm

Code	No.	□"	□	○mm	↳mm↳	↕↔
2496534	GED0350414C	1/4	6,3	4,0	25	13
2517752	GED0354514C	1/4	6,3	4,5	25	14
2496526	GED0350514C	1/4	6,3	5,0	25	14
2517698	GED0355514C	1/4	6,3	5,5	25	14
2496496	GED0350614C	1/4	6,3	6,0	25	12
2496445	GED0350714C	1/4	6,3	7,0	25	14
2496429	GED0350814C	1/4	6,3	8,0	25	17
2496402	GED0350914C	1/4	6,3	9,0	25	19
2523787	GED0351014C	1/4	6,3	10,0	25	20
2523655	GED0351114C	1/4	6,3	11,0	25	24
2523515	GED0351214C	1/4	6,3	12,0	27	29
2523493	GED0351314C	1/4	6,3	13,0	27	28
2523477	GED0351414C	1/4	6,3	14,0	27	30

GED0360

UMSCHALTKNARRE 1/4"



6,3
1/4"

Code	No.	□"	□	↳mm↳	↕↔
2513676	GED0360014C	1/4	6,3	150	165

GED0360

ZAHNRADKNARRE MIT DURCHSTECKVIERKANT 1/4"



6,3
1/4"

Code	No.	□"	□	↳mm↳	↕↔
2511932	GED0360141C	1/4	6,3	150	320

GED0421

VERLÄNGERUNG 1/4"

► Für handbetätigte Steckschlüsseinsätze

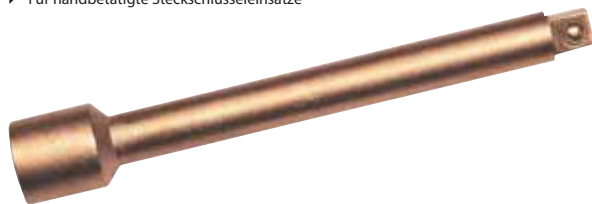

6,3
1/4"

Code	No.	□"	□	↳mm↳	↕↔
2507862	GED0421430C	1/4	6,3	55	20
2506297	GED0421410C	1/4	6,3	100	60
2506289	GED0421420C	1/4	6,3	200	100

GED0410

GELENKGRIFF 1/4"

► Für handbetätigte Steckschlüsseinsätze



6,3
1/4"

Code	No.	□"	□	↳mm↳	↕↔
2507919	GED0410014C	1/4	6,3	165	160
2507900	GED0410015C	1/4	6,3	215	350

GED0400

QUERGRIFF 1/4"

► Für handbetätigte Steckschlüsseinsätze



6,3
1/4"

Code	No.	□"	□	↳mm↳	↕↔
2511916	GED0400014C	1/4	6,3	200	160

GED0400

VIERKANTGRIFF 1/4"

► Für handbetätigte Steckschlüsseinsätze



6,3
1/4"

Code	No.	□"	□	↳mm↳	↕↔
2511908	GED0400015C	1/4	6,3	140	65

GED0400

VERGRÖßERUNGSTÜCK 1/4" - 1/2"

► Für handbetätigte Steckschlüsseinsätze



6,3
1/4"
12,5
1/2"

Code	No.	□"	□	□"	□	↳mm↳	↕↔
2522896	GED0400016C	1/4	6,3	1/2	12,5	30	40

GED0400

VERBINDUNGSVIERKANT 1/4"

► Für handbetätigte Steckschlüsseleinsätze

6,3

1/4"



Code	No.	□ *	□	mm	mm	mm
2503298	GED0400017C	1/4	6,3	25	8	

GED0400

KARDANGELENK 1/4"

► Für handbetätigte Steckschlüsseleinsätze

6,3

1/4"



Code	No.	□ *	□	□ *	□	mm	mm
2514826	GED0400018C	1/4	6,3	1/4	6,3	55	55

GED0430

KNARRENKASTEN 1/4" 16-teilig

► Im Kunststoffkasten, 240x180x60 mm

6,3

1/4"



Code	No.	Inhalt	mm
2503255	GED0430001C	1 Umschaltknarre 1/4" 1 Verlängerung 1/4" 100 mm je 1 Einsatz 1/4" 4 4,5 5 5,5 6 7 8 9 10 11 12 13 14 mm	875

1/2" ANTRIEB

GED035

STECKSCHLÜSSELEINSATZ 1/2" 6-KANT

► Handbetätigt

12,5

1/2"

 mm



Code	No.	□ *	□	mm	mm	mm
2496518	GED0350612S	1/2	12,5	6	40	50
2496488	GED0350712S	1/2	12,5	7	40	55
2496437	GED0350812S	1/2	12,5	8	40	50
2496410	GED0350912S	1/2	12,5	9	40	50
2523795	GED0351012S	1/2	12,5	10	40	50
2523671	GED0351112S	1/2	12,5	11	40	50
2523523	GED0351212S	1/2	12,5	12	40	50
2523507	GED0351312S	1/2	12,5	13	40	50
2523485	GED0351412S	1/2	12,5	14	40	55
2523469	GED0351512S	1/2	12,5	15	40	55
2523442	GED0351612S	1/2	12,5	16	40	60
2523434	GED0351712S	1/2	12,5	17	40	65
2523426	GED0351812S	1/2	12,5	18	40	75
2523396	GED0351912S	1/2	12,5	19	40	85
2523361	GED0352012S	1/2	12,5	20	40	95
2523353	GED0352112S	1/2	12,5	21	40	100
2523337	GED0352212S	1/2	12,5	22	40	110
2523302	GED0352312S	1/2	12,5	23	40	120
2517965	GED0352412S	1/2	12,5	24	40	125
2523280	GED0352512S	1/2	12,5	25	40	130
2523264	GED0352612S	1/2	12,5	26	40	145
2523248	GED0352712S	1/2	12,5	27	40	150
2523213	GED0352812S	1/2	12,5	28	40	175
2523183	GED0352912S	1/2	12,5	29	40	185
2523167	GED0353012S	1/2	12,5	30	40	195
2523140	GED0353212S	1/2	12,5	32	42	240
2523116	GED0353412S	1/2	12,5	34	50	300
2523078	GED0353612S	1/2	12,5	36	50	380
2523019	GED0354112S	1/2	12,5	41	50	450



GED035

STECKSCHLÜSSELEINSATZ 1/2" 6-KANT, LANGE FORM

► Handbetätigt

12,5

1/2"

 mm



Code	No.	□"	□	○ mm	(-mm-)	↕
2524007	GED0350001S	1/2	12,5	10	77	110
2523981	GED0350002S	1/2	12,5	12	77	135
2523973	GED0350003S	1/2	12,5	13	77	105
2523965	GED0350004S	1/2	12,5	14	77	110
2523957	GED0350005S	1/2	12,5	15	77	120
2523949	GED0350006S	1/2	12,5	16	77	125
2523922	GED0350007S	1/2	12,5	17	77	140
2523914	GED0350008S	1/2	12,5	18	82	145
2523906	GED0350009S	1/2	12,5	19	82	180
2523892	GED0350010S	1/2	12,5	21	82	205
2523884	GED0350011S	1/2	12,5	22	82	210
2523876	GED0350012S	1/2	12,5	24	82	250
2523868	GED0350013S	1/2	12,5	27	82	285
2523841	GED0350014S	1/2	12,5	30	82	345
2523833	GED0350015S	1/2	12,5	32	82	375
2523825	GED0350016S	1/2	12,5	34	82	415
2523809	GED0350025S	1/2	12,5	36	82	425

GED035

STECKSCHLÜSSELEINSATZ 1/2" 6-KANT ZOLL

► Handbetätigt

12,5

1/2"

 "AF



Code	No.	□"	□	○ "AF	(-mm-)	↕
2518260	GED0350100S	1/2	12,5	1/4	40	50
2516039	GED0350101S	1/2	12,5	5/16	40	50
2501600	GED0350102S	1/2	12,5	11/32	40	50
2518252	GED0350103S	1/2	12,5	3/8	40	50
2501473	GED0350104S	1/2	12,5	13/32	40	50
2516020	GED0350105S	1/2	12,5	7/16	40	50
2518244	GED0350106S	1/2	12,5	1/2	40	50
2516004	GED0350107S	1/2	12,5	9/16	40	55
2501368	GED0350108S	1/2	12,5	19/32	40	55
2518236	GED0350109S	1/2	12,5	5/8	40	60
2501236	GED0350110S	1/2	12,5	11/16	40	65
2518201	GED0350111S	1/2	12,5	3/4	40	85
2501104	GED0350112S	1/2	12,5	25/32	40	95
2500973	GED0350113S	1/2	12,5	13/16	40	95
2518198	GED0350114S	1/2	12,5	7/8	40	110
2500868	GED0350115S	1/2	12,5	15/16	40	120
2515997	GED0350116S	1/2	12,5	1	40	130
2520273	GED0350117S	1/2	12,5	1.1/16	40	150
2500744	GED0350118S	1/2	12,5	1.1/8	40	175
2520168	GED0350119S	1/2	12,5	1.3/16	40	195
2500612	GED0350120S	1/2	12,5	1.1/4	42	240

GED0360

UMSCHALTKNARRE 1/2"

► Für handbetätigte Steckschlüsseleinsätze

12,5

1/2"

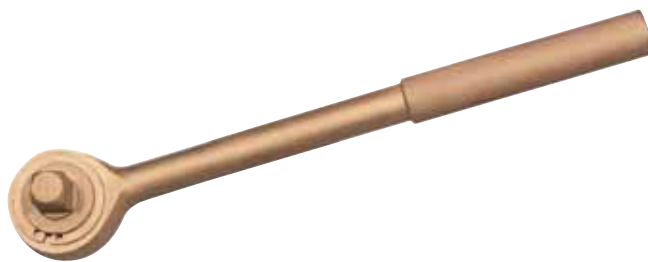

Code	No.	□"	□	(-mm-)	↕
2513684	GED0360012C	1/2	12,5	250	590

GED0360

ZAHNRADKNARRE MIT DURCHSTECKVIERKANT 1/2"

► Für handbetätigte Steckschlüsseleinsätze

12,5

1/2"



Code	No.	□"	□	(-mm-)	↕
2511940	GED0360121C	1/2	12,5	250	430

GED042

VERLÄNGERUNG 1/2"

► Für handbetätigte Steckschlüsseleinsätze

12,5

1/2"



Code	No.	□"	□	(-mm-)	↕
2506335	GED0420002S	1/2	12,5	100	180
2506270	GED0421434S	1/2	12,5	200	315
2506319	GED0420121S	1/2	12,5	250	360

GED0410

GELENKGRIF 1/2"

► Für handbetätigte Steckschlüsseleinsätze

12,5

1/2"



Code	No.	□"	□	(-mm-)	↕
2507935	GED0410012S	1/2	12,5	215	350
2507927	GED0410013S	1/2	12,5	250	560
2507897	GED0410016S	1/2	12,5	300	920
2507870	GED0410101S	1/2	12,5	380	590

GED0400

QUERGRIF 1/2"

► Für handbetätigte Steckschlüsseinsätze

12,5
1/2"



Code	No.	□"	□	■"	■	↳mm↳	↻
2511886	GED04001145	1/2	12,5			250	450
2511924	GED04000125	1/2	12,5			320	550

GED0400

VERGRÖßERUNGSSTÜCK 1/2" - 3/4"

► Für handbetätigte Steckschlüsseinsätze

12,5
1/2"
20
3/4"



Code	No.	□"	□	■"	■	↳mm↳	↻
2522888	GED04001165	1/2	12,5	3/4	20,0	22	120

GED0400

REDUZIERSTÜCK 1/2" - 1/4"

► Für handbetätigte Steckschlüsseinsätze

12,5
1/2"
6,3
1/4"



Code	No.	□"	□	■"	■	↳mm↳	↻
2503271	GED04001195	1/2	12,5	1/4	6,3	40	60

GED0400

VERBINDUNGSVIERKANT 1/2"

► Für handbetätigte Steckschlüsseinsätze

12,5
1/2"



Code	No.	■"	■	↳mm↳	↻
2506408	GED04001175	1/2	12,5	36,5	46

GED0400

KARDANGELENK 1/2"

► Für handbetätigte Steckschlüsseinsätze

12,5
1/2"



Code	No.	■"	■	↳mm↳	↻
2514788	GED04001185	1/2	12,5	70	135

GED0400

WINKELGRIF 1/2"

► Für handbetätigte Steckschlüsseinsätze

12,5
1/2"



Code	No.	■"	■	↳mm↳	↻
2508044	GED04001205	1/2	12,5	220	260
2508036	GED04001215	1/2	12,5	260	400

GED0400

KURBEL 1/2"

► Für handbetätigte Steckschlüsseinsätze

12,5
1/2"



Code	No.	■"	■	↳mm↳	↻
2514176	GED04001225	1/2	12,5	410	615

GED0370

T-GRIFF 1/2"

► Für handbetätigte Steckschlüsseinsätze

12,5
1/2"

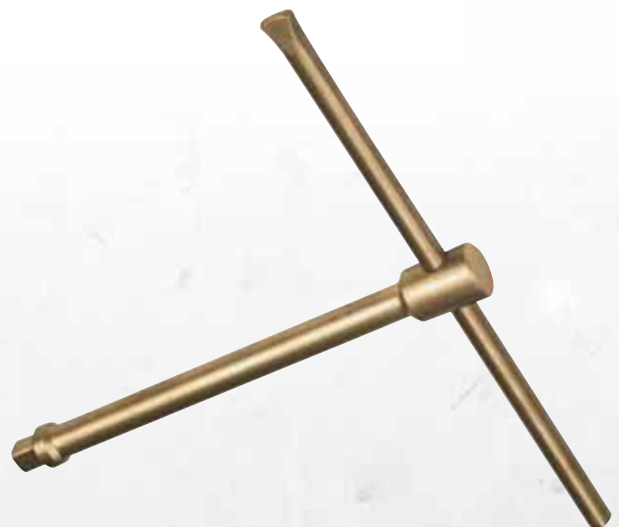

Code	No.	■"	■	↳mm↳	↻
2499231	GED03700125	1/2	12,5	245	500



GED0400

T-GELENKSCHLÜSSEL 1/2"
 ▸ Für handbetätigte Steckschlüsseleinsätze

12,5
1/2"



Code	No.	□"	□	mm	l mm	l
2522861	GED0400123S	1/2	12,5	460	755	

GED0430

KNARRENKASTEN 1/2"
 ▸ Im Kunststoffkasten

12,5
1/2"



Code	No.	Inhalt	-teilig	l
2503204	GED0430005S	1 Umschaltknarre 1/2" 1 Verlängerung 1/2" 100 mm je 1 Einsatz 1/2" 10 11 13 14 15 17 19 22 24 mm	12	5300
2503212	GED0430004S	1 Umschaltknarre 1/2" je 1 Einsatz 1/2" 10 11 12 13 14 15 16 17 18 19 20 21 22 23 24 25 26 27 28 29 30 32 mm	24	4100
2503247	GED0430001S	1 Umschaltknarre 1/2" 1 Verlängerung 1/2", 250 mm je 1 Einsatz 1/2" 10 11 12 13 14 15 16 17 18 19 20 21 22 23 24 25 26 27 28 29 30 32 mm	25	2000
2503239	GED0430002S	1 Umschaltknarre 1/2" 1 Verlängerung 1/2" 250 mm 1 Quergriff 1/2" 320 mm 1 Gelenkgriff 1/2" 380 mm je 1 Einsatz 1/2" 10 11 12 13 14 15 16 17 18 19 20 21 22 23 24 25 26 27 28 29 30 32 mm	27	4100

GED0440

SCHRAUBENDREHEREINSATZ 1/2" für Schlitzschrauben
 ▸ Handbetätigt

12,5
1/2"



Code	No.	□"	□	mm	l mm	l
2499215	GED0440000S	1/2	12,5	4	60	140
2499207	GED0440001S	1/2	12,5	6	60	140
2499193	GED0440002S	1/2	12,5	8	60	140
2496062	GED0440003S	1/2	12,5	10	60	140

GED0440

SCHRAUBENDREHEREINSATZ 1/2" für Kreuzschlitzschrauben PH
 ▸ Handbetätigt

12,5
1/2"



Code	No.	□"	□	PH	l mm	l
2522810	GED0440004S	1/2	12,5	1	60	140
2522802	GED0440005S	1/2	12,5	2	60	140
2522799	GED0440006S	1/2	12,5	3	60	140
2522780	GED0440007S	1/2	12,5	4	60	140

GED0440

SCHRAUBENDREHEREINSATZ 1/2" für Innensechskantschrauben
 ▸ Handbetätigt
 ▸ Mit eingeschweißtem Sechskantstift

12,5
1/2"

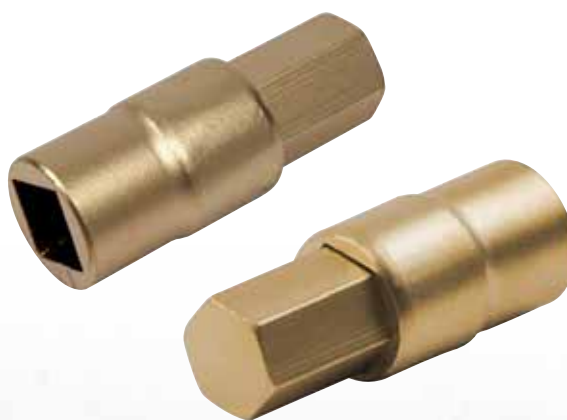

Code	No.	□"	□	mm	l mm	l
2499185	GED0440008S	1/2	12,5	4	60	65
2499177	GED0440009S	1/2	12,5	5	60	70
2499150	GED0440010S	1/2	12,5	6	60	70
2499142	GED0440011S	1/2	12,5	7	60	75
2499134	GED0440012S	1/2	12,5	8	60	80
2499126	GED0440013S	1/2	12,5	9	60	85
2496054	GED0440014S	1/2	12,5	10	60	95
2496046	GED0440015S	1/2	12,5	12	60	115
2496038	GED0440016S	1/2	12,5	14	60	145
2496011	GED0440017S	1/2	12,5	17	60	205
2496003	GED0440018S	1/2	12,5	19	60	230

GED0440

SCHRAUBENDREHEREINSATZ 1/2", LANG für Innensechskantschrauben

- Handbetätigt
- Mit eingeschweißtem Sechskantstift

12,5

1/2"



Code	No.	□"	□	● mm	↳ mm-1	↳ mm-2
2522772	GED0440028S	1/2	12,5	5	90	90
2517574	GED0440029S	1/2	12,5	5	180	125
2522764	GED0440030S	1/2	12,5	6	90	80
2517566	GED0440031S	1/2	12,5	6	140	120
2517558	GED0440032S	1/2	12,5	6	160	135
2517531	GED0440033S	1/2	12,5	7	100	90
2522756	GED0440034S	1/2	12,5	8	90	90
2517523	GED0440035S	1/2	12,5	8	120	105
2517515	GED0440036S	1/2	12,5	10	140	150
2517507	GED0440037S	1/2	12,5	12	140	190
2517493	GED0440038S	1/2	12,5	14	140	250

GED0440

SCHRAUBENDREHEREINSÄTZE-KASTEN 1/2"

- Handbetätigt
- Mit eingeschweißtem Sechskantstift
- Im Holzkasten mit funkenfreiem Scharnier

12,5

1/2"



Code	No.	Inhalt	-teilig	↳ mm-2
2498189	GED0440039S	je 1 Einsatz 1/2" 5 6 7 8 9 10 12 14 17 mm	10	1240
2498057	GED0440040S	1 Umschaltknarre 1/2" 1 Verlängerung 1/2", 250 mm je 1 Einsatz 1/2" 5 6 7 8 9 10 12 14 17 mm	12	2990
2497948	GED0440041S	je 1 Einsatz 1/2" 5 6 7 8 9 10 12 14 17 mm je 1 Einsatz 1/2" 5-90 6-90 8-90 10-140 12-140 14-140 mm	16	2790

3/4" ANTRIEB

GED035

STECKSCHLÜSSELEINSATZ 3/4" 6-KANT

- Handbetätigt

20

3/4"



Code	No.	□"	□	○ mm	↳ mm-1	↳ mm-2
2523418	GED0351834S	3/4	20	18	60	180
2523388	GED0351934S	3/4	20	19	60	180
2523345	GED0352134S	3/4	20	21	60	180
2523310	GED0352234S	3/4	20	22	60	180
2523299	GED0352434S	3/4	20	24	55	350
2523272	GED0352534S	3/4	20	25	55	350
2523256	GED0352634S	3/4	20	26	50	330
2523221	GED0352734S	3/4	20	27	50	300
2523191	GED0352834S	3/4	20	28	50	300
2523175	GED0352934S	3/4	20	29	50	300
2523159	GED0353034S	3/4	20	30	50	310
2523132	GED0353234S	3/4	20	32	60	375
2523124	GED0353334S	3/4	20	33	60	450
2523108	GED0353434S	3/4	20	34	60	465
2523086	GED0353534S	3/4	20	35	55	400
2523051	GED0353634S	3/4	20	36	60	430
2523043	GED0353834S	3/4	20	38	60	490
2523000	GED0354134S	3/4	20	41	65	560
2522993	GED0354234S	3/4	20	42	65	600
2522985	GED0354634S	3/4	20	46	65	655
2522950	GED0355034S	3/4	20	50	70	785
2522942	GED0355534S	3/4	20	55	70	900
2522934	GED0355834S	3/4	20	58	60	950
2522926	GED0356034S	3/4	20	60	70	1290

GED035

STECKSCHLÜSSELEINSATZ 3/4" 6-KANT ZOLL

- Handbetätigt

20

3/4"



Code	No.	□"	□	○ ZAF	↳ mm-1	↳ mm-2
2517663	GED0356035S	3/4	20	7/8	60	180
2499894	GED0356036S	3/4	20	15/16	55	350
2515865	GED0356037S	3/4	20	1	55	350
2520044	GED0356038S	3/4	20	1.1/16	50	300
2499770	GED0356039S	3/4	20	1.1/8	50	300
2499649	GED0356040S	3/4	20	1.1/4	60	375
2519917	GED0356041S	3/4	20	1.5/16	60	400
2499525	GED0356042S	3/4	20	1.3/8	55	400
2519798	GED0356043S	3/4	20	1.7/16	60	430
2501724	GED0356044S	3/4	20	1.1/2	60	490
2519674	GED0356045S	3/4	20	1.9/16	60	490
2499401	GED0356046S	3/4	20	1.5/8	65	560
2513579	GED0356047S	3/4	20	1.11/16	65	560
2499282	GED0356048S	3/4	20	1.3/4	65	600
2512343	GED0356049S	3/4	20	1.13/16	65	655
2499169	GED0356050S	3/4	20	1.7/8	65	655
2515857	GED0356051S	3/4	20	2	70	700



GED0360

UMSCHALTKNARRE 3/4"

► Für handbetätigte Steckschlüsseinsätze

20
3/4"



Code	No.	■"	■	↳mm↳	↕
2499266	GED0360034C	3/4	20	300	1900

GED0360

ZAHNRADKNARRE MIT DURCHSTECKVIERKANT 3/4"

► Für handbetätigte Steckschlüsseinsätze

20
3/4"



Code	No.	■"	■	↳mm↳	↕
2522918	GED0360134C	3/4	20	500	1800

GED04

VERLÄNGERUNG 3/4"

► Für handbetätigte Steckschlüsseinsätze

20
3/4"



Code	No.	■"	■	↳mm↳	↕
2506394	GED0400124S	3/4	20	100	350
2506327	GED0420003S	3/4	20	250	700
2506300	GED0420134S	3/4	20	380	1670
2506386	GED0400126S	3/4	20	430	1500

GED0410

GELENKGRIFF 3/4"

► Für handbetätigte Steckschlüsseinsätze

20
3/4"



Code	No.	■"	■	↳mm↳	↕
2507889	GED0410034S	3/4	20	380	755
2508028	GED0400128S	3/4	20	460	1300
2508001	GED0400129S	3/4	20	550	1950

GED0400

QUERGRIF 3/4"

► Für handbetätigte Steckschlüsseinsätze

20
3/4"



Code	No.	■"	■	↳mm↳	↕
2511851	GED0400130S	3/4	20	260	600
2511894	GED0400034S	3/4	20	500	1480

GED0400

VERGRÖßERUNGSSTÜCK 3/4" - 1"

► Für handbetätigte Steckschlüsseinsätze

20
3/4"
25
1"



Code	No.	□"	□	■"	■	↳mm↳	↕
2522853	GED0400131S	3/4	20	1	25,0	61	325

GED0400

REDUZIERSTÜCK 3/4" - 1/2"

► Für handbetätigte Steckschlüsseinsätze

20
3/4"
12,5
1/2"



Code	No.	□"	□	■"	■	↳mm↳	↕
2503263	GED0400135S	3/4	20	1/2	12,5	57	165

GED0400

VERBINDUNGSVIERKANT 3/4"

► Für handbetätigte Steckschlüsseinsätze

20
3/4"



Code	No.	■"	■	↳mm↳	↕
2506351	GED0400132S	3/4	20	51,5	135

GED0400

KARDANGELN 3/4"

► Für handbetätigte Steckschlüsseinsätze

20
3/4"



Code	No.	■"	■	↳mm↳	↕
2507994	GED0400133S	3/4	20	85	550
2506343	GED0400134S	3/4	20	106	570

GED0400

WINKELGRIFF 3/4"

► Für handbetätigte Steckschlüsseinsätze

20
3/4"



Code	No.	□"	■	□	↳mm↳	↕
2507986	GED0400136S	3/4		20	300	800

GED0400

KURBEL 3/4"

► Für handbetätigte Steckschlüsseinsätze

20
3/4"

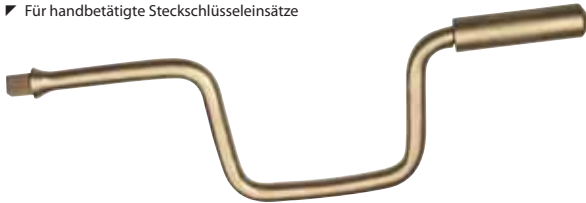

Code	No.	□"	■	□	↳mm↳	↕
2514168	GED0400137S	3/4		20	380	1250

GED0370

T-GRIFF 3/4"

► Für handbetätigte Steckschlüsseinsätze

20
3/4"



Code	No.	□"	■	□	↳mm↳	↕
2499223	GED0370034S	3/4		20	260	850

GED0400

T-GELENKSCHLÜSSEL 3/4"

► Für handbetätigte Steckschlüsseinsätze

20
3/4"



Code	No.	□"	■	□	↳mm↳	↕
2522845	GED0400138S	3/4		20	560	1200

GED0430

KNARRENKASTEN 3/4" 12-teilig

► Im Holzkasten mit funkenfreiem Scharnier

20
3/4"



Code	No.	Inhalt	↕
2503220	GED0430003S	1 Umschaltknarre 3/4" 1 Verlängerung 3/4" 380 mm 1 Quergriff 3/4" 500 mm 1 Gelenkgriff 3/4" 380 mm je 1 Einsatz 3/4" 36 38 41 46 50 55 60 mm	12700

GED0440

SCHRAUBENDREHEREINSATZ 3/4" für Innensechskantschrauben

► Handbetätigt

► Mit eingeschweißtem Sechskantstift

20
3/4"



Code	No.	□"	□	●mm	↳mm↳	↕
2517485	GED0440043S	3/4	20	14	80	350
2517469	GED0440045S	3/4	20	17	80	390
2517450	GED0440046S	3/4	20	19	80	435
2517442	GED0440047S	3/4	20	22	80	480
2517434	GED0440104S	3/4	20	24	80	520
2517426	GED0440105S	3/4	20	27	80	550
2517418	GED0440107S	3/4	20	30	80	570
2517396	GED0440108S	3/4	20	32	80	590
2517388	GED0440109S	3/4	20	36	80	620
2517361	GED0440110S	3/4	20	41	90	720
2517353	GED0440111S	3/4	20	46	90	820



1" ANTRIEB

GED035

STECKSCHLÜSSELEINSATZ 1" 6-KANT

► Handbetätigt



25
1"
mm

Code	No.	□"	□	Ø mm	l mm	l ₂
2517949	GED0353201S	1	25	32	60	510
2517930	GED0353601S	1	25	36	65	550
2517779	GED0354101S	1	25	41	70	730
2517760	GED0354201S	1	25	42	65	710
2517744	GED0354601S	1	25	46	65	710
2517736	GED0355001S	1	25	50	70	930
2517701	GED0355501S	1	25	55	75	1130
2517671	GED0356001S	1	25	60	75	1350
2517655	GED0356501S	1	25	65	75	1500
2517647	GED0357001S	1	25	70	85	1750
2517639	GED0357501S	1	25	75	85	2300
2517620	GED0358001S	1	25	80	85	2500
2517612	GED0358501S	1	25	85	90	2800
2517604	GED0359001S	1	25	90	85	4400
2517582	GED0359501S	1	25	95	85	4500
2496089	GED0354001S	1	25	100	85	4600

GED035

STECKSCHLÜSSELEINSATZ 1" 6-KANT ZOLL

► Handbetätigt



25
1"
"AF

Code	No.	□"	□	Ø "AF	l mm	l ₂
2515946	GED0354002S	1	25	1.7/16	65	550
2517922	GED0354003S	1	25	1.1/2	65	680
2517914	GED0354004S	1	25	1.5/8	70	730
2500361	GED0354005S	1	25	1.11/16	65	710
2500256	GED0354006S	1	25	1.13/16	65	710
2517906	GED0354007S	1	25	1.7/8	65	730
2523035	GED0354008S	1	25	2	70	930
2515938	GED0354009S	1	25	2.1/16	70	950
2515911	GED0354010S	1	25	2.3/16	75	1130
2517884	GED0354012S	1	25	2.3/8	75	1130
2517892	GED0354011S	1	25	2.1/4	75	1350
2515903	GED0354013S	1	25	2.7/16	75	1400
2515873	GED0354014S	1	25	2.9/16	75	1500
2517876	GED0354015S	1	25	2.5/8	75	1550
2517868	GED0354016S	1	25	2.3/4	85	1750
2500132	GED0354017S	1	25	2.13/16	85	1750
2500000	GED0354018S	1	25	2.15/16	85	2300
2523027	GED0354025S	1	25	3	85	2350
2517841	GED0354019S	1	25	3.1/8	85	2500
2517825	GED0354020S	1	25	3.3/8	90	2800
2517817	GED0354021S	1	25	3.1/2	90	4400
2517809	GED0354022S	1	25	3.3/4	90	4500
2517795	GED0354023S	1	25	3.7/8	90	4600
2517787	GED0354024S	1	25	4.1/4	90	5000

GED0360

UMSCHALTKNARRE 1"

► Für handbetätigte Steckschlüsseinsätze



25
1"

Code	No.	□"	□	l mm	l ₂
2506416	GED0360100C	1	25	550	340

GED0360

ZAHNRADKNARRE MIT DURCHSTECKVIERKANT 1"

► Für handbetätigte Steckschlüsseinsätze



25
1"

Code	No.	□"	□	l mm	l ₂
2499258	GED0361100C	1	25	550	3500

GED042

VERLÄNGERUNG 1"

► Für handbetätigte Steckschlüsseinsätze



25
1"

Code	No.	□"	□	l mm	l ₂
2510227	GED0421510S	1	25	100	800
2510219	GED0421520S	1	25	250	1400
2510200	GED0421522S	1	25	400	2090

GED0410

GELENKGRIFF 1"

► Für handbetätigte Steckschlüsseinsätze



25
1"

Code	No.	□"	□	l mm	l ₂
2511835	GED0410100S	1	25	380	1200

GED0400

QUERGRIFF 1"

► Für handbetätigte Steckschlüsseinsätze



25
1"

Code	No.	□"	□	l mm	l ₂
2513668	GED0400139S	1	25	700	3985

GED0400

REDUZIERSTÜCK 1" - 3/4"

► Für handbetätigte Steckschlüsseleinsätze



25
1"
20
3/4"

Code	No.	□"	□	■"	■	↳mm↳	↻
2507943	GED0400142S	1	25	3/4	25,0	75	540

GED0400

VERBINDUNGSVIERKANT 1"

► Für handbetätigte Steckschlüsseleinsätze



25
1"

Code	No.	■"	■	↳mm↳	↻
2507978	GED0400140S	1	25	68,0	325

GED0400

KARDANGELENK 1"

► Für handbetätigte Steckschlüsseleinsätze



25
1"

Code	No.	■"	■	↳mm↳	↻
2515172	GED0400141S	1	25	141	1450

GED0400

WINKELGRIFF 1"

► Für handbetätigte Steckschlüsseleinsätze



25
1"

Code	No.	■"	■	↳mm↳	↻
2511843	GED0400143S	1	25	300	1000

GED0400

KURBEL 1"

► Für handbetätigte Steckschlüsseleinsätze



25
1"

Code	No.	■"	■	↳mm↳	↻
2515083	GED0400144S	1	25	380	1400

GED0400

T-GELENKSCHLÜSSEL 1"



25
1"

Code	No.	■"	■	↳mm↳	↻
2496070	GED0400145S	1	25	660	1700



GED0440

SCHRAUBENDREHEREINSATZ 1" für Innensechskantschrauben

► Handbetätigt
► Mit eingeschweißtem Sechskantstift



25
1"
●

Code	No.	□"	□	●mm	↳mm↳	↻
2495996	GED0440048S	1	25	17	90	580
2495961	GED0440049S	1	25	19	90	665
2495953	GED0440050S	1	25	22	90	710
2495945	GED0440051S	1	25	24	90	765
2495937	GED0440052S	1	25	27	90	860
2495929	GED0440100S	1	25	30	90	910
2495910	GED0440101S	1	25	32	90	950
2495902	GED0440102S	1	25	36	90	990
2495899	GED0440103S	1	25	41	100	1200
2495880	GED0440112S	1	25	46	100	1400

GED0430

KNARRENKASTEN 1"

► Im Holzkasten mit funkenfreiem Scharnier



25
1"

Code	No.	Inhalt	-teilig	↻
2522829	GED0430006S	1 Umschaltknarre 1" 1 Verlängerung 1" 250 mm 1 Verlängerung 1" 400 mm je 1 Einsatz 1" 36 41 46 50 55 60 65 70 75 80 mm 1.1/2 1.5/8 1.7/8 2 2.1/16 2.1/4 2.3/8 2.9/16 2.3/4 3AF	24	33100
2503190	GED0430007S	1 Umschaltknarre 1" 1 Verlängerung 1" 200 mm 1 Verlängerung 1" 400 mm je 1 Einsatz 1" 36 41 46 50 55 60 65 70 75 80 mm	14	21100

KRAFTSCHRAUBER-PROGRAMM FUNKENFREI

1/2" ANTRIEB

GED0351

KRAFTSCHRAUBEREINSATZ 1/2" 6-KANT

- ▶ Maschinenbetätigt
- ▶ Mit Rille und durchgehender Bohrung
- ▶ Schwere Ausführung

12,5

1/2"



Code	No.	□"	□	Ø mm	↳ mm ↵	↳ mm ↵
2512939	GED0351028S	1/2	12,5	10	35	80
2512920	GED0351029S	1/2	12,5	11	35	80
2512912	GED0351030S	1/2	12,5	12	40	85
2512904	GED0351031S	1/2	12,5	13	40	85
2512890	GED0351032S	1/2	12,5	14	40	85
2512882	GED0351033S	1/2	12,5	15	40	90
2512874	GED0351034S	1/2	12,5	16	40	90
2512866	GED0351035S	1/2	12,5	17	40	120
2512858	GED0351036S	1/2	12,5	18	40	125
2512823	GED0351037S	1/2	12,5	19	40	125
2512815	GED0351038S	1/2	12,5	21	40	125
2512807	GED0351039S	1/2	12,5	22	40	120
2512793	GED0351040S	1/2	12,5	23	40	140
2512963	GED0351024S	1/2	12,5	24	48	160
2512947	GED0351027S	1/2	12,5	27	45	190
2512998	GED0351015S	1/2	12,5	30	45	210
2512971	GED0351016S	1/2	12,5	32	45	220

GED0351

KRAFTSCHRAUBEREINSATZ 1/2" 6-KANT, LANGE FORM

- ▶ Maschinenbetätigt
- ▶ Mit Rille und durchgehender Bohrung
- ▶ Schwere Ausführung

12,5

1/2"



Code	No.	□"	□	Ø mm	↳ mm ↵	↳ mm ↵
2506459	GED0351041S	1/2	12,5	8	85	120
2503611	GED0351042S	1/2	12,5	10	85	140
2503603	GED0351043S	1/2	12,5	13	85	175
2503581	GED0351044S	1/2	12,5	14	85	185
2503573	GED0351045S	1/2	12,5	16	85	245
2503565	GED0351046S	1/2	12,5	17	85	250
2503557	GED0351047S	1/2	12,5	18	85	265
2503530	GED0351048S	1/2	12,5	19	85	270
2503522	GED0351049S	1/2	12,5	21	85	305
2503514	GED0351051S	1/2	12,5	22	85	330
2503506	GED0351052S	1/2	12,5	23	85	350
2503492	GED0351053S	1/2	12,5	24	85	370
2503484	GED0351054S	1/2	12,5	27	85	435
2503646	GED0351017S	1/2	12,5	30	85	460
2503638	GED0351018S	1/2	12,5	32	85	490

GED0351

KRAFTSCHRAUBEREINSATZ 1/2"

- ▶ Maschinenbetätigt
- ▶ Mit eingeschweißtem Sechskantstift

12,5

1/2"



Code	No.	□"	□	Ø mm	↳ mm ↵	↳ mm ↵
2523779	GED0351055S	1/2	12,5	5	44	63
2523760	GED0351056S	1/2	12,5	6	44	65
2523752	GED0351057S	1/2	12,5	8	44	75
2518120	GED0351058S	1/2	12,5	10	44	90
2518112	GED0351059S	1/2	12,5	12	50	125
2518104	GED0351060S	1/2	12,5	14	50	130
2518074	GED0351061S	1/2	12,5	17	50	150
2518171	GED0351019S	1/2	12,5	22	50	170
2518163	GED0351020S	1/2	12,5	24	60	210
2518155	GED0351021S	1/2	12,5	27	60	240
2518147	GED0351022S	1/2	12,5	30	60	260
2518139	GED0351023S	1/2	12,5	32	60	270

GED035

VERLÄNGERUNG FÜR KRAFTSCHRAUBEREINSÄTZE 1/2"

12,5

1/2"



Code	No.	□"	□	↳ mm ↵	↳ mm ↵
2499312	GED0351110S	1/2	12	100	250
2499398	GED0351062S	1/2	12	200	380
2499371	GED0351063S	1/2	12	250	470

GED035

VERGRÖßERUNGSTÜCK FÜR KRAFTSCHRAUBEREINSÄTZE 1/2" - 3/4"

12,5

1/2"

20

3/4"



Code	No.	□"	□	□"	□	↳ mm ↵	↳ mm ↵
2496372	GED0351064S	1/2	12,5	3/4	20,0	45	145

GED035
REDUZIERSTÜCK FÜR KRAFTSCHRAUBEREINSÄTZE 1/2" - 1/4"

12,5
1/2
6,3
1/4

Code	No.	□"	□	■"	■	↳mm↳	↕
2503476	GED0351065S	1/2	12,5	1/4	6,3	44	25

GED035
KARDANGELNFK FÜR KRAFTSCHRAUBEREINSÄTZE 1/2"

12,5
1/2

Code	No.	■"	■	↳mm↳	↕
2496364	GED0351066S	1/2	12,5	72	175

GED035
SICHERUNGSRING FÜR KRAFTSCHRAUBEREINSÄTZE 1/2"

Code	No.	Einsatz	Ø	↕
2523744	GED0351067S	bis SW 14 mm	19	5
2523736	GED0351068S	ab SW 15 mm	24	15

GED035
SICHERUNGSSTIFF FÜR KRAFTSCHRAUBEREINSÄTZE 1/2"

Code	No.	Einsatz	Ø	↳mm↳	↕
2518066	GED0351069S	bis SW 14 mm	3	20	10
2523728	GED0351070S	ab SW 15 mm	3	25	15

3/4" ANTRIEB

GED0351
KRAFTSCHRAUBEREINSATZ 3/4" 6-KANT

- ▶ Maschinenbetätigt
- ▶ Mit Rille und durchgehender Bohrung
- ▶ Schwere Ausführung

20
3/4

Code	No.	□"	□	Ø mm	↳mm↳	↕
2512785	GED0351071S	3/4	20	17	45	295
2512777	GED0351072S	3/4	20	18	45	305
2512769	GED0351073S	3/4	20	19	45	305
2512750	GED0351074S	3/4	20	22	48	350
2512742	GED0351075S	3/4	20	24	55	340
2512734	GED0351076S	3/4	20	27	55	380
2512718	GED0351077S	3/4	20	30	50	400
2512696	GED0351078S	3/4	20	32	55	480
2512688	GED0351079S	3/4	20	33	52	425
2512661	GED0351080S	3/4	20	34	55	475
2512653	GED0351081S	3/4	20	36	60	600
2512645	GED0351082S	3/4	20	38	58	485
2512637	GED0351083S	3/4	20	41	65	800
2512629	GED0351109S	3/4	20	46	65	950
2512610	GED0351204S	3/4	20	50	72	1300
2512602	GED0351205S	3/4	20	55	76	1470
2512580	GED0351206S	3/4	20	60	82	1720

GED0351
KRAFTSCHRAUBEREINSATZ 3/4" 6-KANT, LANGE FORM

- ▶ Maschinenbetätigt
- ▶ Mit Rille und durchgehender Bohrung
- ▶ Schwere Ausführung

20
3/4

Code	No.	□"	□	Ø mm	↳mm↳	↕
2503468	GED0351084S	3/4	20	17	90	745
2503441	GED0351085S	3/4	20	19	90	730
2503433	GED0351086S	3/4	20	21	90	750
2503417	GED0351087S	3/4	20	22	90	750
2503409	GED0351088S	3/4	20	24	90	735
2503395	GED0351089S	3/4	20	27	90	665
2503387	GED0351090S	3/4	20	30	90	625
2503379	GED0351091S	3/4	20	32	90	795
2503360	GED0351092S	3/4	20	33	90	715
2503352	GED0351093S	3/4	20	34	90	860
2503344	GED0351094S	3/4	20	36	90	745
2503336	GED0351095S	3/4	20	41	90	925
2503328	GED0351114S	3/4	20	46	90	1150
2503689	GED0350122S	3/4	20	50	90	1610
2503662	GED0350123S	3/4	20	55	90	1800
2503654	GED0350124S	3/4	20	60	90	2150



GED035

KRAFTSCHRAUBEREINSATZ 3/4"
 ▽ Maschinenbetätigt
 ▽ Mit eingeschweißtem Sechskantstift



20
3/4

Code	No.	□"	□	● mm	↳ mm	↳
2518058	GED0351096S	3/4	20	14	50	295
2518031	GED0351097S	3/4	20	17	50	335
2518023	GED0351098S	3/4	20	19	50	345
2518015	GED0351099S	3/4	20	22	50	395

GED035

SICHERUNGSRING FÜR KRAFTSCHRAUBEREINSÄTZE 3/4"



Code	No.	∅	↳
2499320	GED0351107S	36	5

GED035

VERLÄNGERUNG FÜR KRAFTSCHRAUBEREINSÄTZE 3/4"



20
3/4

Code	No.	□"	□	↳ mm	↳
2499363	GED0351101S	3/4	20	100	400
2499355	GED0351102S	3/4	20	250	1300
2499347	GED0351103S	3/4	20	380	1500
2499304	GED0351111S	3/4	20	430	2100

GED035

SICHERUNGSSSTIFT FÜR KRAFTSCHRAUBEREINSÄTZE 3/4"



Code	No.	∅	↳ mm	↳
2523701	GED0351108S	4	35	5

GED035

VERGRÖßERUNGSTÜCK FÜR KRAFTSCHRAUBEREINSÄTZE 3/4" - 1"



20
3/4
25
1"

Code	No.	□"	□	□"	□	↳ mm	↳
2499339	GED0351104S	3/4	20	1	25,0	65	455

GED035

REDUZIERSTÜCK FÜR KRAFTSCHRAUBEREINSÄTZE 3/4" - 1/2"



20
3/4
12,5
1/2

Code	No.	□"	□	□"	□	↳ mm	↳
2496356	GED0351105S	3/4	20	1/2	12,5	65	355

GED035

KARDANGELNK FÜR KRAFTSCHRAUBEREINSÄTZE 3/4"



20
3/4

Code	No.	□"	□	↳ mm	↳
2496321	GED0351106S	3/4	20	110	620

1" ANTRIEB

GED035

KRAFTSCHRAUBEREINSATZ 1" 6-KANT
 ▽ Maschinenbetätigt
 ▽ Mit Rille und durchgehender Bohrung
 ▽ Schwere Ausführung



25
1"

Code	No.	□"	□	∅ mm	↳ mm	↳
2514400	GED0351115S	1	25	22	55	615
2514354	GED0352400S	1	25	24	60	515
2514346	GED0352700S	1	25	27	65	700
2514338	GED0353000S	1	25	30	60	705
2514303	GED0353200S	1	25	32	57	700
2514397	GED0351120S	1	25	33	59	715
2514389	GED0351121S	1	25	34	59	750
2514281	GED0353600S	1	25	36	70	870
2514370	GED0351123S	1	25	38	62	800
2514273	GED0354100S	1	25	41	70	805
2514362	GED0351125S	1	25	42	62	865
2514265	GED0354600S	1	25	46	80	1420
2514257	GED0355000S	1	25	50	70	1250
2514249	GED0355500S	1	25	55	90	1930
2514230	GED0356000S	1	25	60	90	2100
2514222	GED0356500S	1	25	65	90	2300
2514214	GED0357000S	1	25	70	95	2400
2514206	GED0357500S	1	25	75	95	3200
2514184	GED0358000S	1	25	80	96	3750

GED0351

KRAFTSCHRAUBEREINSATZ 1" 6-KANT, LANGE FORM

- ▶ Maschinenbetätigt
- ▶ Mit Rille und durchgehender Bohrung
- ▶ Schwere Ausführung



Code	No.	□"	□	○mm	↳mm↳	↳mm↳
2508354	GED03511345	1	25	22	100	1140
2508346	GED03511355	1	25	24	100	1250
2508311	GED03511365	1	25	27	100	1230
2508303	GED03511375	1	25	30	100	1185
2508281	GED03511385	1	25	32	100	1150
2508273	GED03511395	1	25	33	100	1185
2508265	GED03511405	1	25	34	100	1140
2508257	GED03511415	1	25	36	100	1160
2508249	GED03511425	1	25	38	100	1260
2508230	GED03511435	1	25	41	100	1300
2508222	GED03511445	1	25	46	100	1495

GED0351

KRAFTSCHRAUBEREINSATZ 1"

- ▶ Maschinenbetätigt
- ▶ Mit eingeschweißtem Sechskantstift



Code	No.	□"	□	●mm	↳mm↳	↳mm↳
2496305	GED03511455	1	25	22	80	605
2496291	GED03511465	1	25	24	80	650
2496283	GED03511475	1	25	27	80	655
2496275	GED03511485	1	25	30	80	675
2496267	GED03511495	1	25	32	80	660
2496399	GED03510255	1	25	36	100	1050
2496380	GED03510265	1	25	41	100	1100
2496313	GED03511285	1	25	46	100	1250

GED035

VERLÄNGERUNG FÜR KRAFTSCHRAUBEREINSÄTZE 1"



Code	No.	■"	■	↳mm↳	↳mm↳
2506440	GED03511515	1	25	100	850
2506432	GED03511525	1	25	250	1550
2506424	GED03511535	1	25	400	2050

GED035

VERGRÖßERUNGSSTÜCK FÜR KRAFTSCHRAUBEREINSÄTZE 1" - 1.1/2"



Code	No.	□"	□	■"	■	↳mm↳	↳mm↳
2523612	GED03511545	1	25	1.1/2	40,0	115	1105

GED035

REDUZIERSTÜCK FÜR KRAFTSCHRAUBEREINSÄTZE 1" - 3/4"



Code	No.	□"	□	■"	■	↳mm↳	↳mm↳
2508192	GED03511555	1	25	3/4	20	75	660

GED035

KARDANGELENK FÜR KRAFTSCHRAUBEREINSÄTZE 1"



Code	No.	■"	■	↳mm↳	↳mm↳
2499290	GED03511565	1	25	141	1430

GED035

SICHERUNGSRING FÜR KRAFTSCHRAUBEREINSÄTZE 1"



Code	No.	Einsatz	Ø	↳mm↳
2499274	GED03511575	bis SW 70 mm	45	10
2518007	GED03511585	für SW 75+80 mm	75	25

GED035

SICHERUNGSSSTIF FÜR KRAFTSCHRAUBEREINSÄTZE 1"



Code	No.	Einsatz	Ø	↳mm↳	↳mm↳
2523604	GED03511595	bis SW 70 mm	5	45	5
2515989	GED03511605	für SW 75+80 mm	6	75	15



1.1/2" ANTRIEB

GED035

KRAFTSCHRAUBEREINSATZ 1.1/2" 6-KANT

- ▶ Maschinenbetätigt
- ▶ Mit Rille und durchgehender Bohrung
- ▶ Schwere Ausführung



Code	No.	□*	□	Ø mm	↳ mm	↳
2510367	GED0350121S	1.1/2	40	41	80	2180
2510359	GED0351116S	1.1/2	40	46	80	2245
2510340	GED0351117S	1.1/2	40	50	82	2350
2510332	GED0351118S	1.1/2	40	55	88	2475
2510324	GED0351119S	1.1/2	40	60	91	2755
2510316	GED0351122S	1.1/2	40	65	95	3225
2510308	GED0351124S	1.1/2	40	70	100	3595
2510294	GED0351126S	1.1/2	40	75	105	3720
2510278	GED0351127S	1.1/2	40	80	110	4345
2510251	GED0358500S	1.1/2	40	85	120	5075
2510243	GED0359000S	1.1/2	40	90	120	5630
2510235	GED0359500S	1.1/2	40	95	125	7765
2508389	GED0351000S	1.1/2	40	100	125	8380
2508370	GED0351050S	1.1/2	40	105	125	9550
2508362	GED0351100S	1.1/2	40	110	135	10615
2508214	GED0351150S	1.1/2	40	115	135	10800
2508060	GED0351200S	1.1/2	40	120	145	11785
2508052	GED0351250S	1.1/2	40	125	145	11900

GED035

KRAFTSCHRAUBEREINSATZ 1.1/2" 6-KANT, LANGE FORM

- ▶ Maschinenbetätigt
- ▶ Mit Rille und durchgehender Bohrung
- ▶ Schwere Ausführung



Code	No.	□*	□	Ø mm	↳ mm	↳
2496259	GED0351161S	1.1/2	40	41	140	4420
2496240	GED0351162S	1.1/2	40	46	140	4420
2496232	GED0351163S	1.1/2	40	50	140	4255
2496216	GED0351164S	1.1/2	40	55	140	4330
2496208	GED0351165S	1.1/2	40	60	140	4710
2496194	GED0351166S	1.1/2	40	65	140	5005
2496186	GED0351167S	1.1/2	40	70	140	5250
2496178	GED0351168S	1.1/2	40	75	140	5465
2496151	GED0351169S	1.1/2	40	80	140	5615
2496143	GED0351170S	1.1/2	40	85	140	6175
2496135	GED0351171S	1.1/2	40	90	140	6825
2496127	GED0351172S	1.1/2	40	95	150	10260
2523590	GED0351173S	1.1/2	40	100	150	10395
2523582	GED0351174S	1.1/2	40	105	150	11430
2523566	GED0351175S	1.1/2	40	110	160	12855
2523558	GED0351176S	1.1/2	40	115	160	12680
2523531	GED0351177S	1.1/2	40	120	170	14380

GED035

REDUZIERSTÜCK FÜR KRAFTSCHRAUBEREINSÄTZE 1.1/2" - 1"



Code	No.	□*	□	■*	■	↳ mm	↳
2496119	GED0351178S	1.1/2	40	1	25	95	2300

GED035

SICHERUNGSRING FÜR KRAFTSCHRAUBEREINSÄTZE 1.1/2"



Code	No.	Einsatz	Ø	↳
2515970	GED0351179S	bis SW 90 mm	75	25
2517981	GED0351180S	ab SW 95 mm	114	40

GED035

SICHERUNGSTIFT FÜR KRAFTSCHRAUBEREINSÄTZE 1.1/2"



Code	No.	Einsatz	Ø	↳ mm	↳
2500493	GED0351181S	bis SW 90 mm	8	110	40
2515962	GED0351182S	ab SW 95 mm	8	110	40



2.1/2" ANTRIEB

GED035

KRAFTSCHRAUBEREINSATZ 2.1/2" 6-KANT

- ▶ Maschinenbetätigt
- ▶ Mit Rille und durchgehender Bohrung
- ▶ Schwere Ausführung



Code	No.	□"	□	○ mm	↳ mm	↳
2508184	GED0351183S	2.1/2	63	75	120	9600
2508176	GED0351184S	2.1/2	63	80	120	10100
2508168	GED0351185S	2.1/2	63	85	130	10000
2508141	GED0351186S	2.1/2	63	90	130	10100
2508133	GED0351187S	2.1/2	63	95	130	11200
2508125	GED0351188S	2.1/2	63	100	140	12050
2508117	GED0351189S	2.1/2	63	105	140	12600
2508109	GED0351190S	2.1/2	63	110	150	13800
2508095	GED0351191S	2.1/2	63	115	150	14100
2508079	GED0351192S	2.1/2	63	120	155	15000

GED035

REDUZIERSTÜCK FÜR KRAFTSCHRAUBEREINSÄTZE 2.1/2" - 1.1/2"



Code	No.	□"	□	■"	■	↳ mm	↳
2496097	GED0351193S	2.1/2	63	1.1/2	40	145	6200

GED035

SICHERUNGSRING FÜR KRAFTSCHRAUBEREINSÄTZE 2.1/2"



Code	No.	Einsatz	Ø	↳
2517973	GED0351194S	ab SW 95 mm	114	40

GED035

SICHERUNGSSSTIFT FÜR KRAFTSCHRAUBEREINSÄTZE 2.1/2"



Code	No.	Einsatz	Ø	↳ mm	↳
2515954	GED0351195S	ab SW 95 mm	8	110	40

BITS FUNKENFREI

GED

SCHRAUBENDREHERBIT 1/4" für Schlitzschrauben



Code	No.	mm	●"	●	↳
2522136	GED1264045C	4,5	1/4	6,3	5
2522101	GED1264065C	6,5	1/4	6,3	8
2495708	GED1264080C	8,0	1/4	6,3	10

GED

SCHRAUBENDREHERBIT 1/4" für Kreuzschlitzschrauben PH



Code	No.	Ø PH	●"	●	↳
2502895	GED1264001C	1	1/4	6,3	5
2502887	GED1264002C	2	1/4	6,3	8
2502879	GED1264003C	3	1/4	6,3	10
2502860	GED1264004C	4	1/4	6,3	13

GED

SCHRAUBENDREHERBIT 1/4" für Innensechskantschrauben



Code	No.	● mm	●"	●	↳
2495767	GED1264030C	3	1/4	6,3	4
2495759	GED1264040C	4	1/4	6,3	5
2495732	GED1264050C	5	1/4	6,3	5
2495724	GED1264060C	6	1/4	6,3	7
2495716	GED1264070C	7	1/4	6,3	7
2522098	GED1264100C	10	1/4	6,3	9

GED

SCHRAUBENDREHERBIT 1/4" für Innen-TORX® Schrauben mit Stift



Code	No.	Ø	●"	●	↳
2509733	GED1264101C	T10	1/4	6,3	5
2509725	GED1264102C	T15	1/4	6,3	10
2509717	GED1264103C	T20	1/4	6,3	20
2509709	GED1264104C	T25	1/4	6,3	30
2509695	GED1264105C	T27	1/4	6,3	35
2509687	GED1264106C	T30	1/4	6,3	40
2509679	GED1264107C	T40	1/4	6,3	55



SCHRAUBEN



ENDREHER



SCHRAUBENDREHER



*funkenfrei

SCHRAUBENDREHER FUNKENFREI

GED080

SCHRAUBENDREHER für Schlitzschrauben



Code	No.	mm	mm	
2522616	GED0803075C	3,0	75	30
2497441	GED0804510C	4,5	100	55
2497336	GED0804515C	4,5	150	60
2517213	GED0806010C	6,0	100	80
2517205	GED0806015C	6,0	150	85
2517140	GED0808015C	8,0	150	145
2515733	GED0801020C	10,0	200	185
2515725	GED0801030C	10,0	300	230



GED080

SCHRAUBENDREHER für Schlitzschrauben, parallele Klinge
 ▽ Mit paralleler Klinge



Code	No.	mm	mm	
2517248	GED0800380C	3,0	75	25
2515784	GED0800480C	4,0	150	55
2515768	GED0800580C	5,0	150	75
2515741	GED0800680C	6,0	200	110
2522624	GED0800780C	6,5	300	150

GED081

SCHRAUBENDREHER für Kreuzschlitzschrauben PH



Code	No.	PH	mm	
2512564	GED0810000C	0	60	35
2512556	GED0810010C	1	80	60
2512548	GED0810020C	2	100	90
2512521	GED0810030C	3	150	165
2512513	GED0810040C	4	200	270

GED080

SCHRAUBENDREHER-SÄTZE

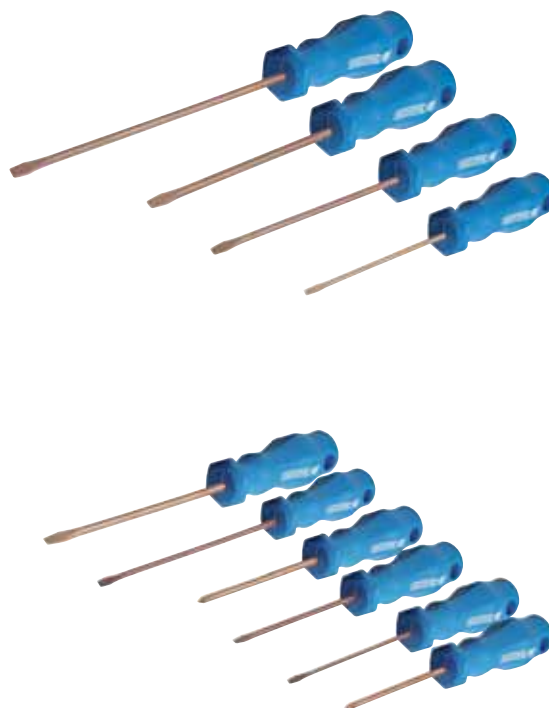

Code	No.	Inhalt	-teilig	
2499088	GED0800001C	⌀ 3x75 mm ⌀ 4,5x100 mm ⌀ 6x150 mm ⌀ 8x150 mm	4	315
2499061	GED0800002C	⌀ 4,5x100 mm ⌀ 6x100 mm 6x150 mm ⌀ 8x150 mm ⊕ PH1 PH2	6	515
2495872	GED0800003C	⌀ 4,5x100 mm 4,5x150 mm ⌀ 6x100 mm 6x150 mm ⌀ 8x150 mm ⌀ 10x200 mm ⊕ PH1 PH2 PH3 PH4	10	1200
2499053	GED0800004C	⊕ PH1 PH2 PH3 PH4	4	585

GED080

SCHRAUBENDREHER für Innen-TORX® Schrauben

▽ TORX® = reg. Markenzeichen der Fa. Acument Intellectual Properties, LLC. USA



Code	No.	T	mm	
2507757	GED0807005C	T5	70	30
2507749	GED0807006C	T6	70	32
2507730	GED0807007C	T7	70	32
2507722	GED0807008C	T8	70	32
2507706	GED0807009C	T9	70	32
2506165	GED0807010C	T10	80	41
2506157	GED0807015C	T15	80	45
2506149	GED0807020C	T20	90	48
2506130	GED0807025C	T25	90	52
2506122	GED0807027C	T27	110	78
2506106	GED0807030C	T30	110	84
2506092	GED0807040C	T40	120	115
2506084	GED0807045C	T45	120	136
2506076	GED0807050C	T50	120	150

GED025

SECHSKANTSCHRAUBENDREHER MIT GRIFF gerade, für Innensechskantschrauben



Code	No.	mm	mm	
2497409	GED0251043S	3	100	35
2497395	GED0251044S	4	100	50
2497387	GED0251045S	5	100	60
2497379	GED0251046S	6	125	90
2497360	GED0251047S	8	150	140
2497352	GED0251048S	10	150	210
2496682	GED0252056S	12	150	280

GED025

SECHSKANTSCHRAUBENDREHER MIT GRIFF gewinkelt, für Innensechskantschrauben



Code	No.	mm	L ₁	L ₂	
2492415	GED0251038S	3	75	20	25
2492407	GED0251039S	4	75	25	40
2492393	GED0251040S	5	80	28	50
2492385	GED0251041S	6	80	32	75
2492377	GED0251042S	8	120	36	140
2492334	GED0251499S	10	120	40	220
2492520	GED0250500S	12	120	45	290

GED080

SECHSKANTSCHRAUBENDREHER MIT GRIFF gerade, für Innensechskantschrauben, mit Kugelkopf



Code	No.	mm	mm	
2515717	GED0807055C	3	100	35
2515709	GED0807060C	4	100	50
2515695	GED0807065C	5	100	60
2515687	GED0807070C	6	125	90
2515679	GED0807075C	8	150	140
2497204	GED0807080C	10	150	210
2497085	GED0807085C	12	150	280

GED025

WINKELSCHRAUBENDREHER-SATZ für Innensechskantschrauben
 Im blauem Einsteckhalter

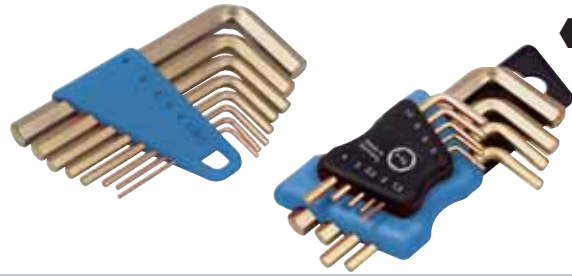

Code	No.	Inhalt	-teilig	
2492660	GED0250001S	● 2 2,5 3 4 5 6 8 10 mm	8	245
2519313	GED0250003S	● 1,5 2 2,5 3 4 5 6 8 10 mm	9	205

GED025

WINKELSCHRAUBENDREHER-SATZ für Innensechskantschrauben ZOLL
 Im blauem Einsteckhalter
 Abbildung ähnlich

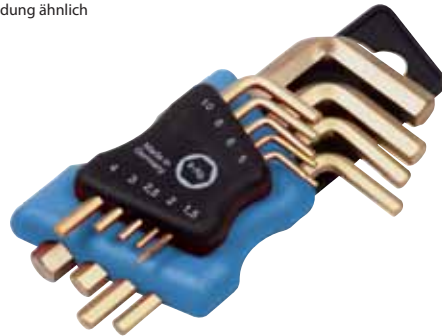

Code	No.	Inhalt	-teilig	
2519348	GED0250002S	● 1/16 5/64 3/32 1/8 5/32 3/16 7/32 1/4 5/16 3/8"	10	178

GED025

WINKELSCHRAUBENDREHER-SATZ für Innensechskantschrauben, extra lang
 Im blauem Einsteckhalter



Code	No.	Inhalt	-teilig	
2492652	GED0250005S	● 2 2,5 3 4 5 6 8 10 mm	8	400
2519275	GED0250004S	● 1,5 2 2,5 3 4 5 6 8 10 mm	9	464

GED025

WINKELSCHRAUBENDREHER-SATZ für Innensechskantschrauben, mit Kugelkopf
 Im blauem Einsteckhalter



Code	No.	Inhalt	-teilig	
2519224	GED0250066C	● 2 2,5 3 4 5 6 8 10 mm	8	250
2504057	GED0250067C	● 1,5 2 2,5 3 4 5 6 8 10 mm	9	260



GED025

WINKELSCHRAUBENDREHER für Innensechskantschrauben

▸ Ähnlich DIN ISO 2936



Code	No.	● mm	↳ mm	↕
2504073	GED0250015C	1,5	55	3
2508532	GED0250020C	2,0	55	2
2504065	GED0250025C	2,5	55	4
2508524	GED0250030S	3,0	60	7
2508516	GED0250040S	4,0	70	12
2508508	GED0250050S	5,0	80	20
2508494	GED0250060S	6,0	90	33
2508486	GED0250070S	7,0	95	45
2508478	GED0250080S	8,0	100	65
2508451	GED0250090S	9,0	105	85
2506904	GED0250100S	10,0	120	100
2506890	GED0250110S	11,0	119	130
2506882	GED0250120S	12,0	125	165
2506874	GED0250130S	13,0	132	200
2506866	GED0250140S	14,0	140	250
2506831	GED0250170S	17,0	160	405
2506823	GED0250180S	18,0	170	500
2506815	GED0250190S	19,0	180	570
2506807	GED0250220S	22,0	200	950
2506793	GED0250240S	24,0	224	1250
2506785	GED0250270S	27,0	250	1800
2506777	GED0250300S	30,0	280	2500
2506769	GED0250320S	32,0	315	3100
2506750	GED0250360S	36,0	355	4500
2506742	GED0250410S	41,0	400	5300

GED025

WINKELSCHRAUBENDREHER für Innensechskantschrauben ZOLL



Code	No.	● "AF"	↳ mm	↕
2504030	GED0251001C	3/64	55	1
2504022	GED0251002C	1/16	55	2
2504014	GED0251003C	5/64	55	2
2504006	GED0251004C	3/32	55	4
2506726	GED0251005C	1/8	60	7
2503999	GED0251006C	5/32	70	12
2503980	GED0251007S	3/16	80	20
2503972	GED0251008S	7/32	80	20
2506718	GED0251009S	1/4	90	33
2503964	GED0251010S	5/16	100	65
2506696	GED0251011S	3/8	120	100
2503956	GED0251012S	7/16	119	130
2506688	GED0251013S	1/2	125	165
2503948	GED0251014S	9/16	140	250

Code	No.	● "AF"	↳ mm	↕
2506661	GED0251015S	5/8	140	266
2499789	GED0251016S	11/16	160	405
2506653	GED0251017S	3/4	180	570
2506645	GED0251018S	7/8	200	950
2510812	GED0251019S	1	224	1260
2497433	GED0251020S	1.1/16	216	3080
2499762	GED0251021S	1.1/8	230	3300
2499754	GED0251022S	1.1/4	230	3300
2497425	GED0251023S	1.5/16	235	3520
2499746	GED0251024S	1.3/8	235	3520
2497417	GED0251025S	1.7/16	241	3740
2499738	GED0251026S	1.1/2	241	3740
2499711	GED0251027S	1.5/8	241	3740

GED025

WINKELSCHRAUBENDREHER für Innensechskantschrauben, extra lang



Code	No.	● mm	↳ mm	↕
2492512	GED0251030S	3	126	6
2492504	GED0251031S	4	142	12
2492490	GED0251032S	5	160	18
2492482	GED0251033S	6	180	30
2492474	GED0251034S	8	200	70
2492466	GED0251035S	10	224	120
2492458	GED0251036S	12	250	190
2492423	GED0251037S	14	280	300
2492350	GED0251123S	17	320	380
2492342	GED0251124S	19	360	490

GED025

WINKELSCHRAUBENDREHER für Innensechskantschrauben, mit Kugelkopf



Code	No.	● mm	↳ mm	↕
2507846	GED0251500C	1,5	45	4
2519216	GED0252000C	2,0	50	3
2507714	GED0252500C	2,5	55	5
2519321	GED0250003C	3,0	63	7
2519283	GED0250004C	4,0	70	12
2519267	GED0250005C	5,0	80	20
2519259	GED0250006C	6,0	90	32
2519240	GED0250007C	7,0	95	42
2519232	GED0250008C	8,0	100	60
2516241	GED0250010C	10,0	115	106
2516233	GED0250012C	12,0	130	205
2516225	GED0250014C	14,0	140	255

GED025

WINKELSCHRAUBENDREHER für Innensechskantschrauben, mit Kugelkopf, extra lang



 mm

Code	No.	mm	mm	
2492547	GED0250115C	3	126	8
2492644	GED0250016C	4	140	18
2492636	GED0250017C	5	160	31
2492628	GED0250018C	6	180	51
2492601	GED0250019C	7	190	75
2492539	GED0250120C	8	200	101
2492598	GED0250021C	10	224	176
2492571	GED0250022C	12	250	292
2492563	GED0250023C	14	290	370

GED080

SECHSKANTSCHRAUBENDREHER MIT T-GRIFF für Innensechskantschrauben, mit Kugelkopf



 mm

Code	No.	mm	mm	
2517191	GED0807090C	3	100	31
2517183	GED0807091C	4	100	38
2517175	GED0807092C	5	150	69
2517167	GED0807093C	6	150	83
2517159	GED0807094C	8	150	118
2515628	GED0807095C	10	200	225
2515636	GED0807096C	12	200	295
2515660	GED0807097C	14	200	380



GED025

SECHSKANTSCHRAUBENDREHER MIT T-GRIFF für Innensechskantschrauben



 mm

Code	No.	mm	mm	
2516160	GED0251049S	3	100	31
2516152	GED0251050S	4	100	38
2516136	GED0251051S	5	100	61
2516128	GED0251052S	6	100	71
2516101	GED0251053S	8	100	97
2507951	GED0251054S	10	100	157
2508567	GED0250055S	12	100	198
2508443	GED0250056S	14	100	246

GED083

WINKELSCHRAUBENDREHER





Code	No.	mm	mm	
2517132	GED0831250S	4	125	25
2517124	GED0831300S	6	130	35
2515601	GED0831400S	10	140	90
2515520	GED0831900S	13	190	240

GED025

SECHSKANTSCHRAUBENDREHER MIT T-GRIFF, LANG für Innensechskantschrauben



 mm

Code	No.	mm	mm	
2516217	GED0250057S	3	150	34
2516209	GED0250058S	4	150	43
2516195	GED0250059S	5	150	69
2516187	GED0250061S	6	150	83
2516179	GED0250062S	8	150	118
2508338	GED0250063S	10	150	191
2508206	GED0250064S	12	150	247
2508087	GED0250065S	14	150	312

GED014

WINKELSCHRAUBENDREHER für Vierkantschrauben



Code	No.	mm	mm	
2492903	GED0140010S	10	200	200
2492881	GED0140011S	11	200	200
2492873	GED0140012S	12	200	200
2492865	GED0140013S	13	200	200
2492857	GED0140014S	14	220	400
2492849	GED0140015S	15	220	400
2492830	GED0140016S	16	220	400
2492822	GED0140017S	17	250	600
2492792	GED0140018S	18	250	600
2492784	GED0140019S	19	250	600
2492776	GED0140020S	20	300	1000
2492768	GED0140021S	21	300	1000
2492741	GED0140022S	22	300	1000
2492733	GED0140024S	24	360	1600
2492725	GED0140025S	25	360	1600
2492717	GED0140027S	27	360	1600
2492709	GED0140028S	28	440	3200
2492695	GED0140030S	30	440	3200
2492679	GED0140032S	32	440	3200

ZANGEN



Zangen



ZANGEN

NON
SPARKING



*funkenfrei

ZANGEN FUNKENFREI

GED053

ROHRZANGE, AMERIKANISCHES MODELL



Code	No.	"inch [E]"	"mm [E]"	
2517337	GED0530230S	3/4	230	600
2517329	GED0530300S	1	300	1125
2517310	GED0530385S	1.1/2	385	1370
2517302	GED0530460S	2	460	2450
2517299	GED0530625S	2.1/2	625	4050
2517280	GED0530850S	3.1/2	850	7350
2515849	GED0531205S	5	1205	13800



GED055

VERSTELLBARER SCHRAUBENSCHLÜSSEL





Code	No.	mm [E]	"mm [E]"	
2507838	GED0554000S	38	240	420
2507811	GED0555000S	45	240	470
2507803	GED0556000S	48	290	780
2507781	GED0557000S	58	350	1000
2507773	GED0558000S	65	350	1200
2507765	GED0559000S	70	425	1600
2507854	GED0551000S	80	500	2200
2506181	GED0551050S	105	575	3700

GED051

ECK-ROHRZANGE

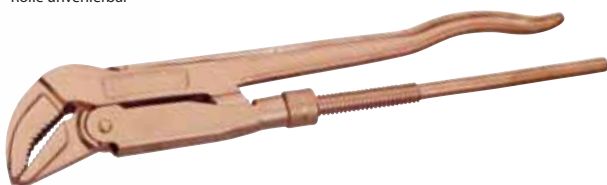
- Für Arbeiten in beengten Raumverhältnissen
- Rolle unverlierbar



Code	No.	"inch [E]"	"mm [E]"	
2515156	GED0510010C	1	320	820
2513641	GED0510015C	1.1/2	430	1570
2515148	GED0510020C	2	540	3200
2515121	GED0510030C	3	700	4100
2515113	GED0510040C	4	790	6200

GED051

ROHRZANGE, SCHWEDISCHES MODELL

- Kopf 90° abgewinkelt
- Rolle unverlierbar

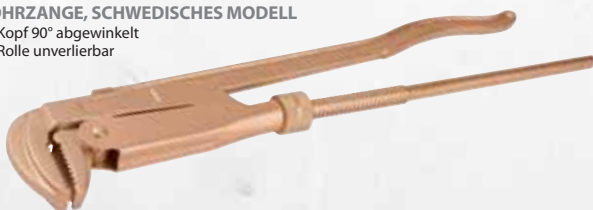

Code	No.	"inch [E]"	"mm [E]"	
2499118	GED0510115C	1.1/2	430	1570
2506203	GED0510120C	2	540	3200

GED048

VERSTELLBARER EINMAULSCHLÜSSEL



Code	No.	mm [E]	"mm [E]"	
2503174	GED0481500C	18	150	100
2503166	GED0482000C	26	200	200
2503158	GED0482500C	30	250	400
2503131	GED0483000C	36	300	700
2503123	GED0483800C	46	380	1400
2503115	GED0484500C	53	450	2700
2503107	GED0486000C	67	600	5100

GED722

KETTENROHRZANGE leichte Ausführung

- Gute Einsatzmöglichkeit an schwer zugänglichen Stellen
- Ratschenähnliche Arbeitsweise



Code	No.	für max. Ø	"mm [E]"	
2521687	GED7220001S	50	600	1700
2521679	GED7220002S	100	600	2500
2498677	GED7220003S	150	600	3000
2521660	GED7220004S	450	1600	8000

GED052

KETTENROHRZANGE amerikanisches Modell

- Hohe Leistung durch maximale Hebelwirkung



Code	No.	für max. Ø	"mm [E]"	
2522748	GED0520510S	38	510	2650
2522721	GED0520685S	65	685	4500
2522705	GED0520915S	100	915	11500
2522691	GED0521830S	300	1830	30300

GED065

GASROHRZANGE



Code	No.	Ø	"mm [E]"	
2510197	GED0652100C	40	210	370

GED060

KOMBINATIONSZANGE

- ▣ Ausführung 160 mm: Griffe blau tauchisoliert
- ▣ Ausführung 200 mm: mit 2-Komponenten-Griffschutzhüllen



Code	No.	↳ mm ↳	↕
2514761	GED0601600C	160	350
2514753	GED0602000C	200	425

GED160

KOMBINATIONSZANGE, ISOLIERT

- ▣ Isoliert bis 1000 V



Code	No.	↳ mm ↳	↕
2522047	GED1601000C	200	390

GED160

VERSTELLBARE KOMBINATIONSZANGE

- ▣ Griffe blau tauchisoliert

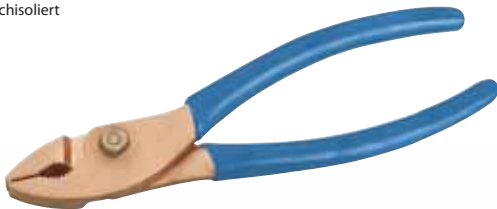

Code	No.	↳ mm ↳	↕
2513838	GED1602000C	200	340

GED066

SEITENSCHNEIDER

- ▣ Mit 2-Komponenten-Griffschutzhüllen



Code	No.	↳ mm ↳	↕
2510189	GED0661650C	165	200

GED066

KRAFT-SEITENSCHNEIDER

- ▣ Mit 2-Komponenten-Griffschutzhüllen



Code	No.	↳ mm ↳	↕
2522659	GED0662650C	190	290

GED066

KRAFT-SEITENSCHNEIDER, ISOLIERT

- ▣ Isoliert bis 1000 V

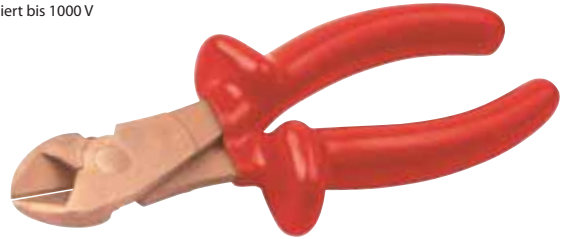

Code	No.	↳ mm ↳	↕
2515830	GED0662651C	190	290



GED050

WASSERPUMPENZANGE

- ▣ Griffe blau tauchisoliert



Code	No.	mm 	↳ mm ↳	↕
2506262	GED0502500C	30	250	370
2506238	GED0503000C	50	300	560
2506211	GED0504000C	110	400	1680

GED060

WASSERPUMPENZANGE

- ▣ Durchgestecktes Gelenk



Code	No.	mm 	↳ mm ↳	↕
2506173	GED0602500C	30	250	350

GED062

RUNDZANGE

- ▣ Mit 2-Komponenten-Griffschutzhüllen



Code	No.	↳ mm ↳	↕
2515059	GED0621200C	120	90
2515032	GED0621600C	160	160

GED061
KNEIFZANGE
 ▸ Griffe blau tauchisoliert

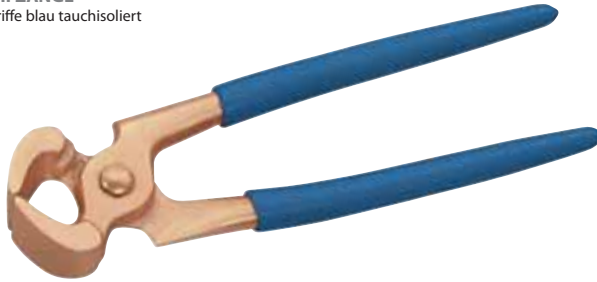

Code	No.	[-mm-]	
2515075	GED0612000C	200	430
2515067	GED0612300C	230	520

GED063
TELEFONZANGE, ISOLIERT gerade
 ▸ Isoliert bis 1000 V



Code	No.	[-mm-]	
2522667	GED0631802C	180	255

GED061
VORNSCHNEIDER starke Ausführung
 ▸ Griffe blau tauchisoliert



Code	No.	[-mm-]	
2522683	GED0611750C	175	260

GED063
TELEFONZANGE gewinkelt
 ▸ Spitzen 45° gewinkelt
 ▸ Griffe blau tauchisoliert



Code	No.	[-mm-]	
2522675	GED0631801C	180	245

GED064
FLACHZANGE
 ▸ Ausführung 120 mm: mit 2-Komponenten-Griffschutzhüllen
 ▸ Ausführung 160 mm: Griffe blau tauchisoliert

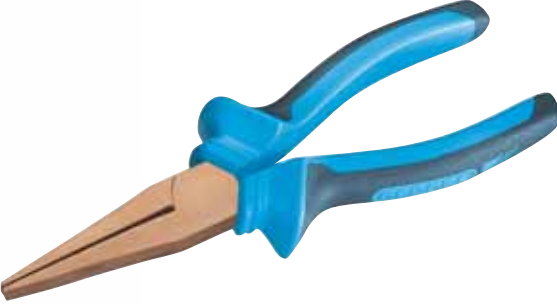

Code	No.	[-mm-]	
2514737	GED0641200C	120	50
2514729	GED0641600C	160	150

GED061
ABISOLIERZANGE
 ▸ Selbstöffnend, mit Feder und Feststellschraube



Code	No.	[-mm-]	
2511827	GED0611550C	170	260

GED063
TELEFONZANGE gerade
 ▸ Mit 2-Komponenten-Griffschutzhüllen



Code	No.	[-mm-]	
2513633	GED0631800C	180	300

GED068
MONTAGEZANGE FÜR AUSSENSICHERUNGSRINGE Form A
 ▸ Griffe blau tauchisoliert



Code	No.	● mm	[-mm-]	
2517272	GED0680310C	3-10	140	110
2515822	GED0681025C	10-25	140	120
2515814	GED0681960C	19-60	180	220
2497824	GED0684010C	40-100	225	300
2497700	GED0688516C	85-165	310	700
2519550	GED0681253C	125-300	500	1200

GED069

MONTAGEZANGE FÜR INNENSICHERUNGSRINGE Form C
 ▽ Griffe blau tauchisoliert

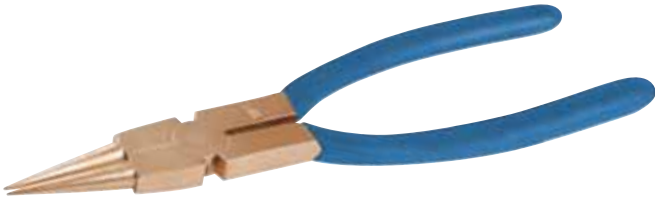

Code	No.	Ø mm	l mm	
2522640	GED0690825C	8-25	140	120
2517264	GED0691960C	19-60	180	220
2515806	GED0694010C	40-100	225	300
2515792	GED0698516C	85-165	290	700
2497565	GED0691253C	125-300	500	1200

GED999

BOLZENSCHNEIDER
 ▽ Griffe blau tauchisoliert



Code	No.	l mm	
2509385	GED9991031C	620	3400

GED062

CRIMPZANGE
 ▽ Griffe blau tauchisoliert

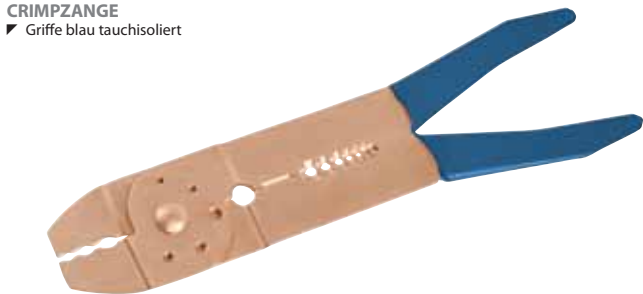

Code	No.	l mm	
2514745	GED0621001C	200	120

GED725

ZANGEN-SATZ 4-teilig



Code	No.	Inhalt	
2513099	GED7250008C	Kombinationszange 200 mm Seitenschneider 165 mm Telefonzange 180 mm Wasserpumpenzange 250 mm	1500

GED0702

BLECHSCHERE amerikanisches Modell



Code	No.	l mm	
2514141	GED0702800C	300	450

GED0702

IDEALSCHERE verstärkt
 ▽ Für gerade durchlaufende und Figurenschnitte



Code	No.	l mm	
2522632	GED0702750C	280	520

GED0712

VIELZWECKSCHERE



Code	No.	l mm	
2510170	GED0712100C	210	300



GED0712

ARBEITSSCHERE



Code	No.	l mm	
2512572	GED0712000C	220	225



SCHLAGW



* funkenfrei

WERKZEUGE



HÄMMER / SCHLAGWERKZEUGE



HÄMMER / SCHLAGWERKZEUGE FUNKENFREI

GED100

SCHLOSSERHAMMER

- ▶ Mit Hickorstiel
- ▶ Ähnlich DIN 1041, Bahn und Pinne geschliffen



Code	No.	↕
2522594	GED1000100S	100
2522586	GED1000150S	150
2522578	GED1000200S	200
2522543	GED1000300S	300
2522527	GED1000400S	400
2522500	GED1000500S	500
2522497	GED1000600S	600
2522470	GED1000700S	700
2522454	GED1000800S	800
2522446	GED1000900S	900
2517086	GED1001000S	1000
2517078	GED1001250S	1250
2517043	GED1001500S	1500
2517027	GED1002000S	2000

GED100

SCHLOSSERHAMMER

- ▶ Mit nahezu unzerbrechlichem Fiberglasstiel
- ▶ Ähnlich DIN 1041, Bahn und Pinne geschliffen



Code	No.	↕
2522551	GED1000300F	300
2522535	GED1000400F	400
2522519	GED1000500F	500
2522462	GED1000800F	800
2517094	GED1001000F	1000
2517051	GED1001500F	1500
2517035	GED1002000F	2000

GED104

VORSCHLAGHAMMER

- ▶ Mit Hickorstiel
- ▶ Ähnlich DIN 1042, Bahn und Pinne geschliffen



Code	No.	↕
2509873	GED1042500S	2500
2509857	GED1043000S	3000
2509830	GED1044000S	4000
2509814	GED1045000S	5000
2509806	GED1046000S	6000
2509776	GED1048000S	8000
2509768	GED1049000S	9000
2507668	GED1041000S	10000
2507641	GED1041200S	12000
2507633	GED1041500S	15000

GED104

VORSCHLAGHAMMER

- ▶ Mit nahezu unzerbrechlichem Fiberglasstiel
- ▶ Ähnlich DIN 1042, Bahn und Pinne geschliffen



Code	No.	↕
2509865	GED1043000F	3000
2509849	GED1044000F	4000
2509822	GED1045000F	5000
2509792	GED1048000F	8000
2507676	GED1041000F	10000

GED103

FÄUSTEL

- ▶ Mit Hickorstiel
- ▶ Bahn geschliffen



Code	No.	↕
2510138	GED1031000S	1000
2510103	GED1031250S	1250
2510073	GED1031500S	1500
2510057	GED1032000S	2000
2510022	GED1032500S	2500
2510006	GED1033000S	3000
2509989	GED1034000S	4000
2509962	GED1035000S	5000
2509946	GED1036000S	6000
2509881	GED1038000S	8000
2507684	GED1031100S	10000

GED103

FÄUSTEL

- ▣ Mit nahezu unzerbrechlichem Fiberglasstiel
- ▣ Bahn geschliffen



Code	No.	STK
2510146	GED1031000F	1000
2510111	GED1031250F	1250
2510081	GED1031500F	1500
2510065	GED1032000F	2000
2510049	GED1032500F	2500
2510014	GED1033000F	3000
2509997	GED1034000F	4000
2509970	GED1035000F	5000
2509954	GED1036000F	6000
2509938	GED1038000F	8000
2507692	GED1031100F	10000

GED113

MINENHAMMER

- ▣ Mit Hickorstiel
- ▣ Bahn geschliffen



Code	No.	STK
2514095	GED1131000S	1000
2514087	GED1131500S	1500
2514060	GED1132500S	2500
2514052	GED1133500S	3500
2514044	GED1135000S	5000
2514036	GED1138000S	8000

GED113

MINENHAMMER

- ▣ Mit nahezu unzerbrechlichem Fiberglasstiel
- ▣ Bahn geschliffen



Code	No.	STK
2513625	GED1131000F	1000
2513617	GED1131500F	1500
2513609	GED1132500F	2500
2513595	GED1133500F	3500
2513560	GED1135000F	5000
2513552	GED1138000F	8000

GED102

SCHLOSSERHAMMER amerikanische Form

- ▣ Mit Hickorstiel



Code	No.	STK
2522438	GED1020100S	100
2522411	GED1020150S	150
2522403	GED1020200S	200
2522381	GED1020300S	300
2522373	GED1020400S	400
2522365	GED1020500S	500
2522349	GED1020600S	600
2522330	GED1020700S	700
2522322	GED1020800S	800
2522314	GED1020900S	900
2517019	GED1021000S	1000
2517000	GED1021300S	1300
2516985	GED1021500S	1500
2516977	GED1022000S	2000



GED109

HANDHAMMER amerikanische Form



Code	No.	STK
2522306	GED1090700S	700
2516969	GED1091200S	1200
2516950	GED1091600S	1600

GED108

SETZHAMMER

- ▣ Mit Hickorstiel



Code	No.	STK
2514702	GED1081500S	1500

GED116

LOCH-/DURCHSCHLÄGER

▾ Mit Hickorystiel



Code	No.	↕
2498944	GED1161000S	1000
2498936	GED1162000S	2000
2498898	GED1163000S	3000
2498871	GED1165000S	5000

GED112

MASCHINISTENHAMMER amerikanische Form

▾ Mit Hickorystiel



Code	No.	↕
2505924	GED1120100S	100
2505916	GED1120300S	300
2505908	GED1120500S	500
2505894	GED1120600S	600
2505878	GED1120800S	800
2505851	GED1120900S	900
2503085	GED1121100S	1100

GED106

KLAUENHAMMER

▾ Mit Hickorystiel



Code	No.	↕
2514133	GED1060300S	300
2514125	GED1060400S	400
2514117	GED1060500S	500
2514109	GED1060600S	600

GED701

MAURERHAMMER

▾ Mit Hickorystiel
▾ Ähnlich DIN 5108



Code	No.	↕
2513803	GED7010600S	600
2513781	GED7010800S	800
2513250	GED7010900S	1000

GED703

MAURERHAMMER amerikanische Form

▾ Mit Hickorystiel



Code	No.	↕
2511754	GED7030700S	700

GED105

KESSELSTEIN-/ENTROSTUNGSHAMMER

▾ Mit Hickorystiel



Code	No.	↕
2507625	GED1050200S	200
2507617	GED1050400S	400
2507609	GED1050500S	500
2507587	GED1050600S	600
2507579	GED1050800S	800
2507560	GED1050900S	900
2505932	GED1051400S	1400

GED702

SCHLEGEL

▾ Mit Hickorystiel



Code	No.	↕
2495538	GED7020900S	900
2521970	GED7021800S	1800
2521962	GED7022700S	2700



GED704

SCHROTMEISSEL

- ▀ Mit Hickorstiel



Code	No.	mm
2513242	GED7041300S	1300
2513234	GED7042100S	2100

227 E

GUMMIHAMMER weich

- ▀ DIN 5128-60, 60 Shore A
- ▀ Mit zwei flachen Bahnen
- ▀ **2 A** mit einer balligen und einer flachen Bahn
- ▀ Mit Eschenstiel



Code	No.	mm	mm	mm	mm	mm
8826660	227 E-0	80	260	40	150	6
8826740	227 E-1	90	320	55	320	6
8826820	227 E-2	115	340	65	540	6
8826900	227 E-2 A	115	340	65	430	6
8827040	227 E-3	130	380	75	770	6
8827120	227 E-4	140	380	90	1050	6

GED705

DURCHTREIBER

- ▀ Mit Hickorstiel



Code	No.	mm	mm
2513773	GED7050800S	8	800
2513196	GED7051800S	10	800
2513226	GED7051200S	12	1200
2513188	GED7052200S	16	1200

228

HOLZHAMMER

- ▀ Komplett aus Weißbuchenholz
- ▀ Nach DIN 7462 A



Code	No.	mm	mm	mm	mm
8828010	228-60	300	60	350	6
8828280	228-70	340	70	470	6



RÜCKSCHLAGFREIE HÄMMER FUNKENFREI



Rückschlagfreie Hämmer

- ▀ Alle **Power Drive®** rückschlagfreien Hämmer werden in den USA mit Nuplaglas® Fiberglasstielen hergestellt.
- ▀ Das patentierte schlagbelastbare Verbundmaterial der Innenhohlräume ist mit einer äußeren robusten Schutzhülle aus Polymer umhüllt.
- ▀ Dies führt zu einer Steigerung der Schlagkraft um 40 % sowie zu einer Abnahme des Rückschlags, verglichen mit anderen Hämmern dieser Art.
- ▀ Das speziell konstruierte Material der Schlagoberfläche sorgt für einen extremen Oberflächenschutz und für eine unglaubliche Widerstandsfähigkeit.
- ▀ Oberflächen aus Messing sind ebenfalls verfügbar, damit es sich um eine funkenfreie Version handelt.

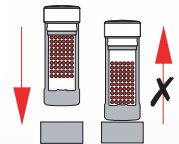

226 E

GUMMIHAMMER hart

- ▀ DIN 5128-90, 90 Shore A
- ▀ Mit zwei flachen Bahnen
- ▀ **2 A** mit einer balligen und einer flachen Bahn
- ▀ Mit Eschenstiel



Code	No.	mm	mm	mm	mm	mm
8825500	226 E-0	80	260	40	210	6
8825690	226 E-1	90	320	55	370	6
8825770	226 E-2	115	340	65	630	6
8825850	226 E-2 A	115	340	65	578	6
8825930	226 E-3	130	380	75	990	6
8826070	226 E-4	140	380	90	1460	6

GEDSFN

RÜCKSCHLAGFREIER HAMMER

- ▀ Mit Nuplaglas® Fiberglasstiel

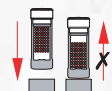

Code	No.	mm	mm
2495341	GEDSFN1SG	40	800
2521431	GEDSFN2SG	50	1000
2521423	GEDSFN3SG	60	1300
2521415	GEDSFN4SG	70	1600

GEDSDS

RÜCKSCHLAGFREIER HAMMER mit funkenfreier Schlagfläche
 ▸ Mit Nuplaglas® Fiberglasstiel

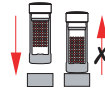

Code	No.	Ø mm	↕
2511509	GEDSDSFB-2SG	50	1000

GEDSTPN

RÜCKSCHLAGFREIER HAMMER mit festen Kunststoffaufsätzen
 ▸ Mit Nuplaglas® Fiberglasstiel

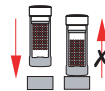

Code	No.	Ø mm	↕
2495333	GEDSTPN16	16	450
2495325	GEDSTPN24	24	675

GEDSPI

RÜCKSCHLAGFREIE HALTERUNG ohne Aufsatz
 ▸ Mit Nuplaglas® Fiberglasstiel



Code	No.	Ø mm	↕
2521407	GEDSPI106N	25	350
2521393	GEDSPI156N	40	500
2516691	GEDSPI206N	50	1000
2516683	GEDSPI256N	65	2000
2516675	GEDSPI306N	75	3000

GEDSPS

KUNSTSTOFFHAMMER ohne Aufsatz
 ▸ Mit Nuplaglas® Fiberglasstiel



Code	No.	Ø mm	↕
2511371	GEDSPS105N	25	250
2511266	GEDSPS150N	40	450
2511142	GEDSPS155N	40	300
2511002	GEDSPS200N	50	700
2494515	GEDSPS205N	50	1000
2494396	GEDSPS250N	65	1150
2494272	GEDSPS255N	65	1950
2494159	GEDSPS300N	75	1500
2494035	GEDSPS305N	75	3000
2493918	GEDSPS306N	75	3400
2493780	GEDSPS307N	75	3700



weich



mittelweich



mittelhart



hart



hart



extra hart



Messing

GED10

AUFSÄTZE 25 MM Ø für SPI106N, SPS105N

Code	No.	Ø mm	Härte	↕
2514443	GED10H-N	25	hart	40
2514427	GED10M-N	25	mittelhart	40
2514893	GED10S-N	25	weich	40
2513765	GED10SN-N	25	mittelweich	40
2502798	GED10T-N	25	hart	40
2511983	GED10XH-N	25	extrahart	40

GED15

AUFSÄTZE 40 MM Ø für SPS150N, SPS155N, SPI156N

Code	No.	Ø mm	Härte	↕
2513463	GED15B-N	40	Messing	40
2514907	GED15H-N	40	hart	40
2509547	GED15M-N	40	mittelhart	40
2505509	GED15S-N	40	weich	40
2505770	GED15SN-N	40	mittelweich	40
2514885	GED15T-N	40	hart	40
2509520	GED15XH-N	40	extrahart	40

GED20

AUFSÄTZE 50 MM Ø für SPS200N, SPS205N, SPI206N

Code	No.	Ø mm	Härte	↕
2513269	GED20B-N	50	Messing	130
2514877	GED20H-N	50	hart	90
2509490	GED20M-N	50	mittelhart	90
2514478	GED20S-N	50	weich	90
2505568	GED20SN-N	50	mittelweich	100
2514869	GED20T-N	50	hart	100
2509482	GED20XH-N	50	extrahart	100

GED25				
AUFSÄTZE 65 MM Ø für SPS250N, SPS255N, SPI256N				
Code	No.	Ø mm	Härte	
2502771	GED25H-N	65	hart	70
2516802	GED25M-N	65	mittelhart	70
2507536	GED25S-N	65	weich	70
2516721	GED25SN-N	65	mittelweich	70
2505525	GED25T-N	65	hart	70
2505495	GED25XH-N	65	extrahart	70

GED30				
AUFSÄTZE 75 MM Ø für SPS305N, SPS307N, SPI306N				
Code	No.	Ø mm	Härte	
2514850	GED30H-N	75	hart	240
2509474	GED30M-N	75	mittelhart	240
2514451	GED30S-N	75	weich	270
2505541	GED30SN-N	75	mittelweich	270
2514842	GED30T-N	75	hart	280
2509466	GED30XH-N	75	extrahart	310

MEISSEL FUNKENFREI

GED115				
FLACHMEISSEL flachoval				
▶ Schneide gratfrei				
Code	No.	l mm	b mm	
2522292	GED1150150S	150	20	200
2522284	GED1150200S	200	25	320
2522276	GED1150250S	250	25	550
2522268	GED1150300S	300	25	560
2522241	GED1150400S	400	30	630
2522225	GED1150450S	450	30	750
2522217	GED1150500S	500	30	920

GED115				
SCHLITZMEISSEL flach				
▶ Schneide gratfrei				
Code	No.	l mm	b mm	Höhe
2498979	GED1150001S	200	25	5
2498960	GED1150002S	250	25	5
2498952	GED1150003S	300	25	5

GED709				
MAURERMEISSEL 6-kant				
▶ Ähnlich DIN 7254				
▶ Schneide gratfrei				
Code	No.	l mm	b mm	
2495511	GED7090006S	200	6	35
2521938	GED7090008S	150	8	40
2521911	GED7090010S	150	10	120
2521903	GED7090014S	150	14	200
2521792	GED7090200S	200	14	250
2521784	GED7090250S	250	14	300
2521814	GED7090140S	300	14	400
2521881	GED7090017S	150	17	300
2521806	GED7090170S	250	17	450
2521776	GED7090300S	300	17	550

Code	No.	l mm	b mm	
2521873	GED7090020S	200	19	500
2521946	GED7090002S	250	19	600
2521768	GED7090350S	350	19	850
2521725	GED7090400S	400	19	1000
2521849	GED7090023S	250	22	850
2521857	GED7090022S	300	22	1000
2521717	GED7090500S	500	22	1600
2521709	GED7090600S	600	22	2000
2521830	GED7090027S	250	27	580
2521822	GED7090050S	300	32	850

GED116				
KREUZMEISSEL oval				
▶ Schneide gratfrei				
Code	No.	l mm	b mm	
2522209	GED1160150S	150	8	250
2522195	GED1160200S	200	8	340
2522187	GED1160250S	250	8	480
2522179	GED1160300S	300	10	640



GED710				
KREUZMEISSEL 6-kant				
▶ Schneide gratfrei				
Code	No.	l mm	Ø mm	
2502720	GED7100200S	200	14	270
2502712	GED7100250S	250	14	330
2502704	GED7100300S	300	17	550
2502682	GED7100400S	400	19	960

GED708				
SPITZMEISSEL 6-kant				
Code	No.	l mm	Ø mm	
2502763	GED7080200S	200	14	270
2502755	GED7080250S	250	14	330
2502747	GED7080300S	300	17	550
2502739	GED7080400S	400	19	960

GED711				
BETONMEISSEL				
Code	No.	l mm	Höhe	Breite
2513757	GED7110380S	380	45	33

108 UNI

HANDSCHUTZGRIFF

- ▶ Aus PVC
- ▶ Durch eine vergrößerte und doppelte Schutzplatte höchste Sicherheit für die Hand bei Fehlschlägen
- ▶ Ergonomische Gestaltung
- ▶ Vermeidet Handverletzungen
- ▶ Kein Wegrollen durch Ellipsenform
- ▶ Prellschläge übertragen sich nicht in die Hand
- ▶ Keine Ermüdung der Hand - griffig und sicher
- ▶ Für alle Meißel ab 250 mm Länge geeignet
- ▶ DBGm (Deutsches Bundes-Gebrauchsmuster)



product
design
award

2008

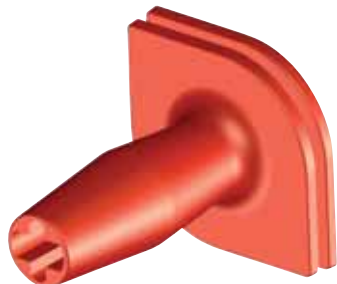

Code	No.	oval	8-kant	↕↔	↕↔
8658500	108 UNI	20 x 12 23 x 13 26 x 13 26 x 7	14 16 18 20	182	1



SPLINT-/DURCHTREIBER FUNKENFREI

GED120

REISSNADEL



Code	No.	↳ mm ↳	∅	↕↔
2514974	GED1201900S	190	4	50
2514966	GED1202250S	225	6	50

GED195

WINKELDORN



Code	No.	L	B	∅	↕↔
2495643	GED1950300S	300	100	13	200
2495635	GED1950400S	450	150	19	1300
2495619	GED1950401S	450	150	16	930
2495600	GED1950402S	450	150	24	2000
2495597	GED1950403S	450	150	27	2300
2495589	GED1950404S	450	150	30	3300
2495570	GED1950405S	500	150	16	1300
2495562	GED1950406S	600	200	20	2400
2495554	GED1950407S	800	200	22	3400

GED081

VIERTANT-AHLE



Code	No.	↕↔	↕↔
2512505	GED0810060S	100	80

GED118

DURCHTREIBER konisch

- ▶ Ähnlich DIN 6458



Code	No.	L	s	d	↕↔
2503026	GED1180010S	120	1	8	35
2503018	GED1180020S	120	2	8	35
2502992	GED1180030S	120	3	8	35
2502984	GED1180040S	120	4	8	40
2502976	GED1180050S	120	5	10	60
2502968	GED1180060S	120	6	10	60
2502941	GED1180070S	120	7	10	65
2502925	GED1180080S	120	8	10	65
2502917	GED1180090S	150	9	13	135
2498855	GED1180100S	150	10	13	140
2498847	GED1180120S	160	12	16	220
2498839	GED1180140S	160	14	16	230
2498820	GED1180160S	200	16	20	500
2498812	GED1180180S	200	18	20	500
2498804	GED1180200S	200	20	24	620
2498790	GED1180220S	200	22	24	640

GED118

DURCHTREIBER konisch, starke Ausführung



Code	No.	L	s	d	↕↔
2515164	GED1180011S	150	6	13	100
2515040	GED1180012S	150	7	17	100
2514923	GED1180013S	200	8	21	395
2496844	GED1180014S	250	12	24	645
2516942	GED1180130S	250	13	30	865

GED118

DURCHTREIBER konisch, extra starke Ausführung



Code	No.	L	s	d	↕↔
2522160	GED1180500S	220	5	16	255
2496712	GED1181000S	230	10	19	420
2532921	GED1180015S	250	13	24	880

GED118

DURCHTREIBER spindelförmig



Code	No.	L	s	d	↕↔
2505843	GED1180004S	200	8	17	230
2505835	GED1180005S	200	8	21	360
2503077	GED1180006S	200	10	24	415
2503050	GED1180007S	200	13	27	630
2503042	GED1180008S	200	18	30	880
2503034	GED1180009S	200	22	32	1050

GED117

KÖRNER



Code	No.	l (mm)	Ø	±
2495856	GED1170100S	100	3	30
2495848	GED1170110S	110	4	60
2495821	GED1170125S	125	5	100
2495813	GED1170150S	150	6	200

GED118

DURCHTREIBER-SATZ 6-teilig

Im Kunststoffhalter



Code	No.	Inhalt	±
2507552	GED1180001S	je 1 Durchtreiber 1 2 3 4 5 mm 1 Körner 4 mm	310

GED119

SPLINTTREIBER

Ähnlich DIN 6450



Code	No.	l (mm)	s	d	±
2509741	GED1190150S	110	1,5	10	45
2512491	GED1190200S	110	2,0	10	50
2512483	GED1190300S	110	3,0	10	45
2512467	GED1190400S	120	4,0	10	50
2512459	GED1190500S	130	5,0	10	50
2512440	GED1190600S	140	6,0	10	60
2512432	GED1190800S	150	8,0	12	100
2511800	GED1191000S	160	10,0	12	120
2511797	GED1191300S	180	13,0	16	240
2511789	GED1191600S	200	16,0	16	400

GED119

SPLINTTREIBER starke Ausführung



Code	No.	l (mm)	s	d	±
2522144	GED1191500S	150	6	14	120
2516918	GED1190100S	180	10	14	160
2516926	GED11900135S	200	13	18	290
2516896	GED1190160S	300	16	20	655

GED162

MONTIERSPITZE



Code	No.	l (mm)	s	d	±
2512378	GED1620500S	500	5	20	1200

GED118

SPLINTTREIBER-SATZ 6-teilig

Im Kunststoffhalter



Code	No.	Inhalt	±
2498863	GED1180002S	je 1 Splinttreiber 3 4 5 6 8 10 mm	440

GED120

ZUGDORN

Ähnlich DIN 6459



Code	No.	l (mm)	d	±
2515547	GED1200008S	85	8	40
2515431	GED1200010S	90	10	50
2515423	GED1200013S	100	13	70
2515415	GED1200016S	110	16	100
2515393	GED1200019S	140	19	180
2515385	GED1200021S	160	21	270
2515377	GED1200025S	200	25	450
2515369	GED1200029S	240	29	630

GED120

MONTAGEDORN



Code	No.	l (mm)	s	d	±
2515016	GED1200005S	180	5	12	110
2515008	GED1200006S	200	6	13	150
2514982	GED1200080S	200	8	16	220
2514990	GED1200009S	200	9	20	340
2514648	GED1200100S	230	10	22	460
2514699	GED1200011S	250	11	25	620
2514680	GED1200012S	280	12	27	870
2514664	GED1200014S	320	14	30	1260
2514656	GED1200015S	350	15	32	1570
2514621	GED1200160S	380	16	36	2230

GED136

GEWINDEREINIGUNGSSTIFT



Code	No.	l (mm)	Ø	±
2514559	GED1360006S	300	6	75
2496593	GED1360007S	300	10	180
2496461	GED1360008S	300	13	350

MESSER, S



SPACHTEL



MESSER, SPACHTEL, SCHABER

*funkenfrei



NON
SPARKING

MESSER, SPACHEL, SCHABER FUNKENFREI

GED190

STRICKEISEN/STRICKWERKZEUG



Code	No.	Breite	↕
2512955	GED1900002C	2	370
2512831	GED1900003C	3	410
2512726	GED1900004C	4	390
2512599	GED1900005C	5	520
2512475	GED1900006C	6	420
2512351	GED1900007C	7	500
2512238	GED1900008C	8	520
2512106	GED1900009C	9	520
2495007	GED1900010C	10	525
2494884	GED1900012C	12	540

GED073

MESSER

- ▶ Stabile und feststehende Klinge
- ▶ Mit Holzgriff



Code	No.	↕	mm	mm	↕
2515458	GED0731800C	80	180	75	

GED073

MESSER verstärkte Ausführung

- ▶ Stabile und feststehende Klinge
- ▶ Mit Holzgriff



Code	No.	↕	mm	mm	↕
2517256	GED0731801S	200	300	300	

GED139

SPACHEL biegsam



Code	No.	L	B	↕
2505827	GED1390040C	210	40	75
2505819	GED1390050C	210	50	80
2505800	GED1390060C	210	60	95
2505797	GED1390080C	230	80	90
2505789	GED1390090C	230	90	115
2502844	GED1390100C	230	100	125

GED140

SPACHEL starr



Code	No.	L	B	↕
2509636	GED1400030S	210	30	110
2509628	GED1400040S	220	40	120
2509601	GED1400050S	220	50	150
2509598	GED1400060S	220	60	165
2509571	GED1400080S	240	80	190
2509563	GED1400090S	240	90	215
2507544	GED1400100S	240	100	240

GED723

SCHABERSPACHEL biegsam



Code	No.	L	B	↕
2521652	GED7230000C	175	78	125

GED999

SPACHTELMESSER



Code	No.	mm	Blattlänge	Blattbreite	
2511630	GED9991052S	260	150	25	85
2511614	GED9991053S	350	230	40	145
2511606	GED9991054S	490	355	50	275

GED136

WINKELSCHABER

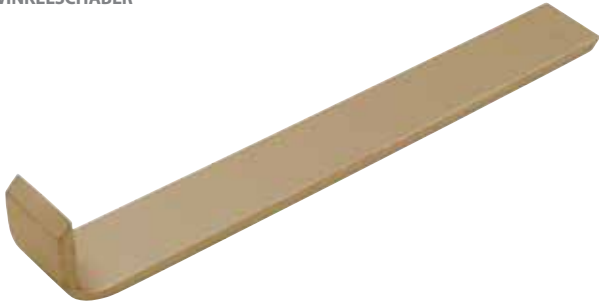

Code	No.	L	B	
2512416	GED1360200S	200	22	210
2512408	GED1360255S	255	45	480
2512394	GED1360300S	300	50	570

GED136

WINKELSCHABER MIT GRIF



Code	No.	L	B	
2516829	GED1360380S	380	38	780

GED714

SPRITZKABINENSCHABER

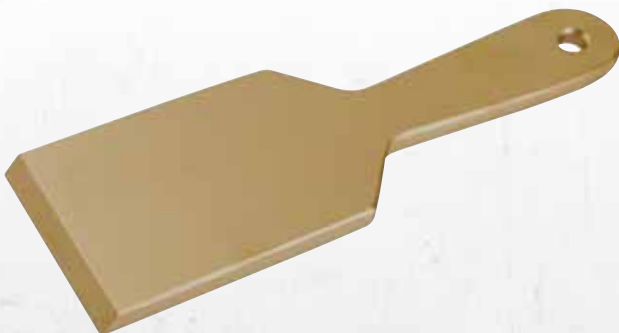

Code	No.	mm	
2495481	GED7140001S	235	450

GED138

FLACHSCHABER

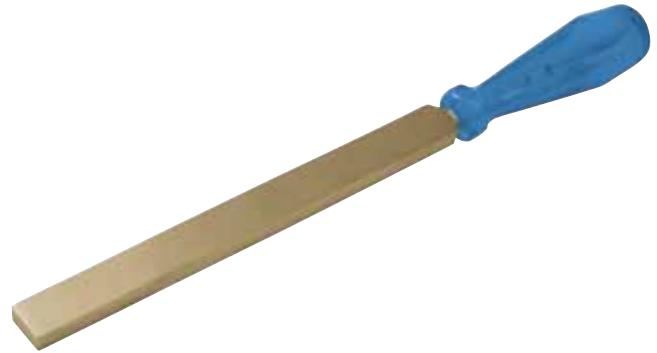

Code	No.	mm	mm	
2513544	GED1380200S	200	310	290

GED137

DREIKANTSCHABER

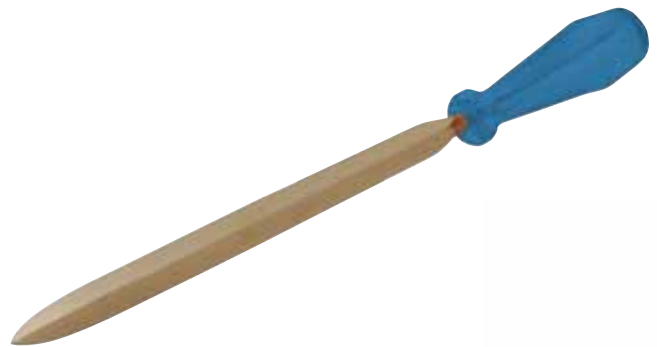

Code	No.	mm	mm	
2509644	GED1372000S	200	310	220

GED135

DREIKANT-PLATTENSCHABER



Code	No.	mm	Klingenlänge	Klingenbreite	
2516837	GED1355000S	420	100	70	650

GED715

SCHABER MIT STIEL



Code	No.	L	B	→←
2498685	GED7150001S	480	95	620

GED133

ROSTSTECHER

▣ Mit Stiel



Code	No.	L	B	→←
2516888	GED1330600S	600	75	530
2516845	GED1330800S	800	75	620
2514818	GED1331000S	1000	75	740
2514672	GED1331200S	1200	75	1160

GED131

SCHABER

▣ Auf Wunsch mit Stiel



Code	No.	L	B	→←
2515350	GED1310750S	220	75	580
2515202	GED1311000S	220	100	830
2515199	GED1311250S	220	125	880
2515180	GED1311500S	220	150	1020

GED139

MAURERKELLE



Code	No.	→←	Blattbreite	Blattlänge	→←
2514028	GED1390130S	335	130	215	350
2514001	GED1390135S	360	135	240	540

GED132

SCHABER KONKAV

▣ Auf Wunsch mit Stiel



Code	No.	L	B	→←
2511762	GED1321000S	240	100	900
2511746	GED1321500S	240	150	1350

GED139

GLÄTTKELLE



Code	No.	Blattlänge	Blattbreite	→←
2514591	GED1390280S	280	120	810

GED139

SPITZKELLE



Code	No.	Blattbreite	
2514605	GED13901605	160	180

GED134

REINIGUNGSWERKZEUG



Code	No.	L	B	
2502852	GED13448005	480	1200	

GED139

FUGENKELLE



Code	No.	Blattbreite	
2514958	GED13900105	10	113

GED134

FUSSBODENSCHABER



Code	No.	L	B	
2509652	GED13415005	170	150	720

GED723

BREITSPACHTEL starres Blatt



Code	No.	L	B	
2498650	GED72300125	195	120	250
2498642	GED72300145	195	140	270
2498634	GED72300165	205	160	300
2502666	GED72300185	205	160	350

GED131

PLATTENSCHABER



Code	No.	L	B	
2512424	GED13100755	150	75	500
2511770	GED13101255	235	125	800

BÜRSTEN,



SCHRUBBER



BÜRSTEN, SCHRUBBER



SPARKING

*funkenfrei

BÜRSTEN, SCHRUBBER FUNKENFREI

GED176

BÜRSTE Zinnbronzedraht, gewellt



Code	No.	L	B	↕
2511665	GED17618005	180	70	300

GED175

HANDFEGER Zinnbronzedraht, gewellt

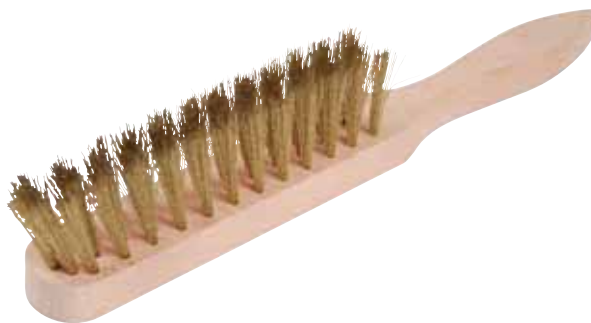

Code	No.	↔ mm ↔	↕
2505754	GED1750007S	310	320

GED175

SCHRUBBER

▾ Auf Wunsch mit Stiel



Code	No.	Maße	↕
2509512	GED1752450S	245x65x40	480

GED175

DRAHTBÜRSTE Zinnbronzedraht, gewellt



Code	No.	Reihen	↔ mm ↔	↕
2511703	GED1750030S	3	350	190
2511681	GED1750040S	4	350	210
2511673	GED1750050S	5	350	190

GED175

HANDBÜRSTE Zinnbronzedraht, gewellt

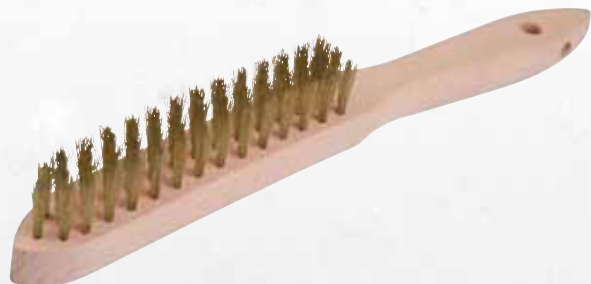

Code	No.	Reihen	↔ mm ↔	↕
2512335	GED1750008S	3	290	110
2512327	GED1750009S	4	290	130
2512319	GED1750010S	5	290	150

GED175

BESEN Runddraht, glatt

▾ Mit Stiel



Code	No.	Maße	↕
2520836	GED1753000S	300x70x100	1500



GED121

GUMMISCHIEBER
 ▽ Aus Holz, mit Stiel



Code	No.	↔mm↔	
2502909	GED1210735S	600	300

GED176

ZÜNDKERZENBÜRSTE Runddraht, glatt



Code	No.	↔mm↔	
2522039	GED1761900S	145	25

GED179

ZYLINDERBÜRSTE Draht, gewellt



Code	No.	↔mm↔	
2522020	GED1790320S	300	42

GED175

PINSELBÜRSTE Draht, gewellt



Code	No.	∅	Schafthöhe	Schaft-∅
2495678	GED1750006S	26	25	6

GED177

RUNDBÜRSTE Zinnbronzedraht, gewellt



Code	No.	Aufnahme-∅	∅	
2498758	GED1770150S	22,2	150	520

GED178

TOPFBÜRSTE Zinnbronzedraht, gewellt



Code	No.	Aufnahme-∅	∅	
2498731	GED1780150S	22,2	125	700



BEILE, SCH





BEILE, SCHAUFELN, SPATEN, HACKEN



*funkenfrei

BEILE, SCHAUFELN, SPATEN, HACKEN FUNKENFREI

GED716

HAUE
 ▾ Mit Buchenstiel



Code	No.	↳mm↳	mm²	↕
251555	GED7160001S	950	120	2300

GED145

BEIL
 ▾ Mit Hickorystiel



Code	No.	↳mm↳	↕
2515539	GED1451000S	450	1300
2515512	GED1451500S	450	1500

GED145

FEUERWEHRBEIL
 ▾ Mit Fiberglasstiel



Code	No.	↳mm↳	↕
2522071	GED1450900C	400	900

GED717

HANDPICKEL



Code	No.	L	B	↕
2514419	GED7170001S	380	225	1000

GED146

AXT
 ▾ Mit Hickorystiel



Code	No.	↳mm↳	↕
2515571	GED1467500S	750	1600
2515563	GED1469000S	900	2200

GED719

GRUBENPICKEL
 ▾ Auf Wunsch mit Buchenstiel



Code	No.	↳mm↳	↕
2513110	GED7190001S	400	2200

GED717

FEUERWEHRAXT
 ▾ Mit Hickorystiel
 ▾ Ähnlich DIN 14900



Code	No.	↳mm↳	↕
2513129	GED7170000S	800	2600

GED718

EINREISSHAKEN
 ▾ Ähnlich DIN 14851
 ▾ Ohne Stiel



Code	No.	L	B	↕
2512165	GED7180001S	380	176	1800



GED125

KREUZHACKE

- ▣ Mit Buchenstiel
- ▣ Ähnlich DIN 20109



Code	No.	L	B	
2495783	GED1255801S	800	400	2150
2495775	GED1255802S	950	500	3500
2495791	GED1255800S	950	550	4000

GED126

SPITZHACKE

- ▣ Mit Buchenstiel



Code	No.	L	B	
2514613	GED1265600S	950	650	4100

GED152

SPATEN

- ▣ Mit Buchenstiel



Code	No.	Blattlänge	Blattbreite	↳mm↳	Griffform	
2514931	GED1521160S	260	180	1250	T	3500
2514915	GED1521161S	260	180	1250	D	3650

GED152

KLAPPSPATEN

- ▣ Mit Buchenstiel



Code	No.	Blattlänge	Blattbreite	↳mm↳	
2509555	GED1521260S	320	180	740	1300

GED153

FRANKFURTER SCHAUFEL

- ▣ Mit Buchenstiel



Code	No.	Blattlänge	Blattbreite	↳mm↳	Griffform	
2495694	GED1531250S	340	260	1400	gerade	1850
2522055	GED1531251S	340	260	1150	D	1850



GED150

HANDSCHAUFEL
 ▾ Mit Buchenstiel



Code	No.	Blattlänge	Blattbreite	H mm	Griffform	↕
2498774	GED1501280S	400	270	1400	gerade	1950
2512386	GED1501281S	400	270	1150	D	1950

GED151

DUNGGABEL
 ▾ Mit Buchenstiel



Code	No.	Blattlänge	Blattbreite	H mm	↕
2516810	GED1511600S	330	230	1600	1640

GED151

HANDSCHAUFEL
 ▾ Mit Buchenstiel



Code	No.	Blattlänge	Blattbreite	H mm	↕
2513536	GED1510540S	220	180	540	720

GED151

SPATENGABEL
 ▾ Mit Buchenstiel



Code	No.	Blattlänge	Blattbreite	H mm	Griffform	↕
2496348	GED1511000S	290	180	1000	D	1265



GED151

HEUGABEL

▣ Mit Buchenstiel



Code	No.	Blattlänge	Blattbreite	(mm)	
2522063	GED15111005	290	180	1600	1280

GED151

RECHEN

▣ Mit Buchenstiel



Code	No.	L	B	
2498766	GED15112005	1600	360	1530

GED151

GABEL FÜR SCHIESSBAUMWOLLE

▣ Auf Wunsch mit Buchenstiel



Code	No.	Blattlänge	Blattbreite	(mm)	
2519429	GED15113005	140	90	200	600
2519305	GED15114005	250	150	370	1305

GED000

SICHEL



Code	No.	(mm)	
2515466	GED00010025	250	800

GED000

HECKENSCHERE



Code	No.	Schneidenlänge	
2513722	GED0001001C	300	1400



KEILE, BR



*funkenf

ECHSTANG



KEILE, BRECHSTANGEN



KEILE, BRECHSTANGEN FUNKENFREI

GED186

FLANSCHKEIL

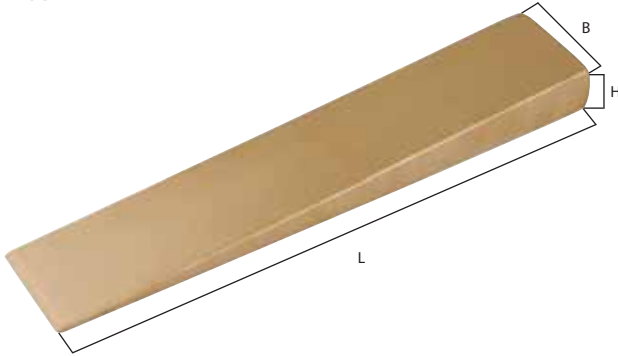

Code	No.	L	B	H	
2509504	GED1860010S	80	15	6	40
2507528	GED1860011S	90	50	10	200
2505746	GED1860001S	100	50	10	210
2505673	GED1860006S	105	19	13	100
2505738	GED1860002S	150	25	13	215
2505711	GED1860003S	150	30	13	280
2505665	GED1860007S	150	38	19	400
2505703	GED1860004S	150	40	13	425
2505622	GED1860012S	180	32	13	300
2505614	GED1860013S	180	50	10	400
2505657	GED1860008S	180	50	19	700
2505606	GED1860014S	200	38	25	900
2505592	GED1860015S	200	38	41	1300
2505649	GED1860009S	200	40	40	1380
2505584	GED1860016S	200	50	19	800
2505576	GED1860017S	215	50	32	1400
2505681	GED1860005S	230	40	20	1000

GED185

KEIL mit Loch

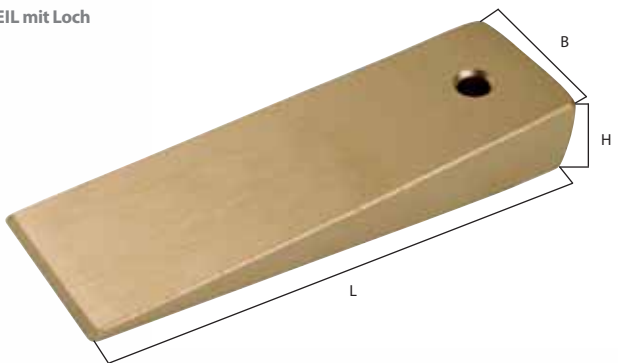



Code	No.	L	B	H	Loch-Ø	
2498715	GED1851000S	100	30	15	6	220

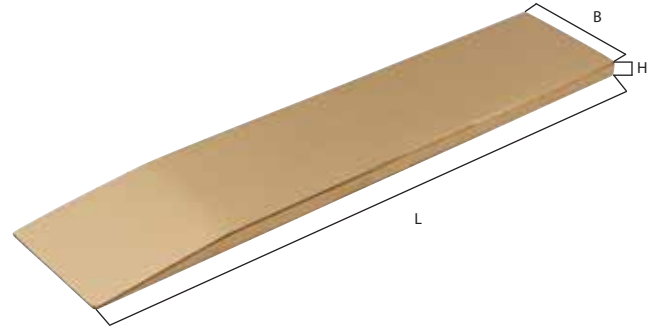

GED186

SPACE-EISEN





Code	No.	L	B	H	mm±	
2495651	GED1861002S	250	50	5	1,5	200

GED186

NASENKEIL

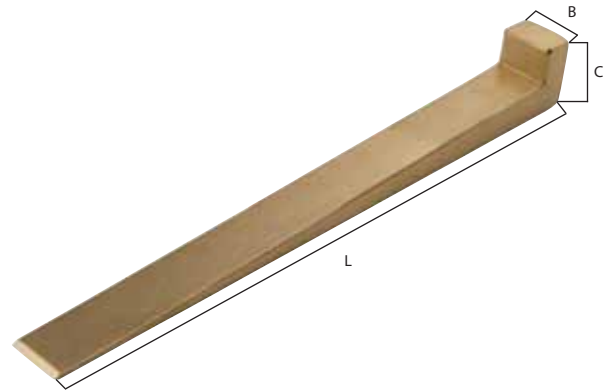
► Für formschlüssige Verbindungen von der Welle und Nabe.



Code	No.	L	B	H	Schaftbreite	Schafthöhe	
2521466	GED9991034S	340	20	40	20	20	2600
2521989	GED1861001S	340	30	40	20	20	2800
2522004	GED1861000S	400	30	40	40	15	3500

GED712

STEINKEIL

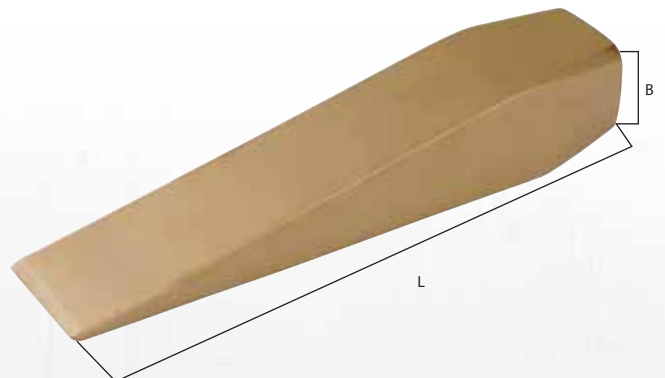

Code	No.	L	B	
2513161	GED7120001S	120	44	1100
2513153	GED7120002S	150	45	1400
2513145	GED7120003S	190	47	2000
2513137	GED7120004S	240	50	3000

GED720

FLANSCHMESSER gerade, mit Dorn

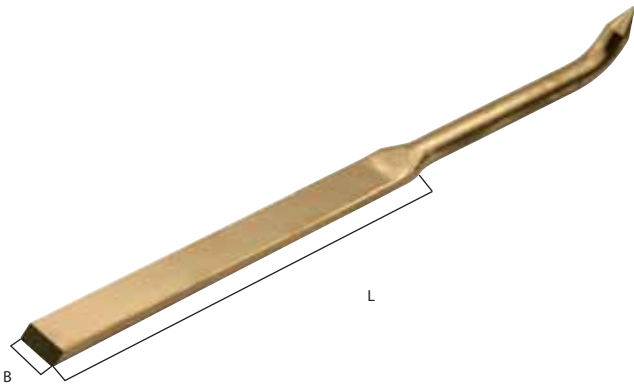

Code	No.	mm	mm	Schneidenlänge	
2495473	GED720001S	400	25	220	300

GED161

KISTENEISEN



Code	No.	mm	mm	
2513935	GED1613000S	300	14	400
2513927	GED1614500S	450	19	1100
2513919	GED1616000S	600	19	1500
2513900	GED1617500S	750	22	2500
2513897	GED1619000S	900	22	3000

GED720

FLANSCHMESSER rund



Code	No.	mm	mm	Schneidenlänge	
2495465	GED720002S	690	30	400	1200
2521695	GED720003S	1240	40	800	2000

GED160

BRECHSTANGE



Code	No.	mm	mm	
2513994	GED1600450S	450	19	1100
2513986	GED1600600S	600	19	1500
2513978	GED1600750S	750	22	2500
2513951	GED1600900S	900	22	3000
2513455	GED1601000S	1000	22	3300
2513439	GED1601250S	1250	27	6100
2513420	GED1601500S	1500	27	7300
2513412	GED1601800S	1800	30	11100
2513404	GED1602000S	2000	30	12300



GED161

NAGELEISEN/KNIPPEISEN



Code	No.	mm	mm	
2513706	GED1610300S	300	14	400
2513587	GED1610450S	450	9	1100
2513447	GED1610600S	600	19	1500
2513323	GED1610750S	750	22	2500
2513218	GED1610900S	900	22	3000

GED160

BRECHSTANGE mit Spitze und Schneide



Code	No.	mm	Ø	
2514435	GED1600001S	1000	30	6150
2514311	GED1600002S	1250	30	7700
2514192	GED1600003S	1500	30	9250
2514079	GED1600004S	1800	30	11100
2513943	GED1600005S	2000	30	12300

GED160

BRECHSTANGE mit Spitze und Klaue



Code	No.	l-mm	Ø	W
2496224	GED1600006S	1000	30	6150
2496100	GED1600007S	1250	30	7700
2495988	GED1600008S	1500	30	9250
2495864	GED1600009S	1800	30	11100
2495740	GED1600010S	2000	30	12300

GED160

BRECHSTANGE mit Schneide und Kugel



Code	No.	l-mm	Ø	W
2516799	GED1600011S	1000	30	6150
2516780	GED1600012S	1250	30	7700
2516772	GED1600013S	1500	30	9250
2516764	GED1600014S	1800	30	11100
2516756	GED1600015S	2000	30	12300

GED160

BRECHSTANGE mit Spitze und Kugel



Code	No.	l-mm	Ø	W
2495627	GED1600016S	1000	30	6150
2495503	GED1600017S	1250	30	7700
2495384	GED1600018S	1500	30	9250
2495260	GED1600019S	1800	30	11100
2495120	GED1600020S	2000	30	12300

GED162

HEBESTANGE



Code	No.	l-mm	W	W
2514583	GED1620650S	650	20	2000
2514575	GED1620800S	800	20	2700
2513889	GED1621000S	1000	20	3400
2513870	GED1621250S	1250	25	6200
2513862	GED1621500S	1500	25	7700

GED163

MONTIEREISEN



Code	No.	L	s	SW	W
2513331	GED1632000S	200	5	19	660
2513315	GED1633000S	300	5	19	1000
2513307	GED1634000S	400	5	19	1300
2513293	GED1635000S	500	5	19	1600
2513285	GED1636000S	600	5	19	2000

GED163

MONTIERHEBEL



Code	No.	l-mm	W
2513390	GED1630200S	200	350
2513382	GED1630305S	300	470
2513374	GED1630400S	400	600
2513366	GED1630500S	500	770
2513358	GED1630600S	600	900



GED163

MONTIERHEBEL schwere, gekröpfte Ausführung



Code	No.	↳mm↳	↕
2495686	GED1630610S	600	1000

GED020

KARBIDTROMMELÖFFNER



Code	No.	↳mm↳	↕
2499797	GED0203000S	300	750

GED724

VERSCHLAGÖFFNER



Code	No.	↳mm↳	↕
2509423	GED7240001S	230	455

GED092

FASSHEBER



Code	No.	↳mm↳	max. kg	↕
2514710	GED0920600S	1060	600	3800

Kennen Sie unsere Einzel-Kataloge...



Gesamtkatalog



@work



Forstwerkzeuge



Kfz-Spezialwerkzeuge



SONSTIGE



NOW
sparking



HA N D W E



SONSTIGE HANDWERKZEUGE

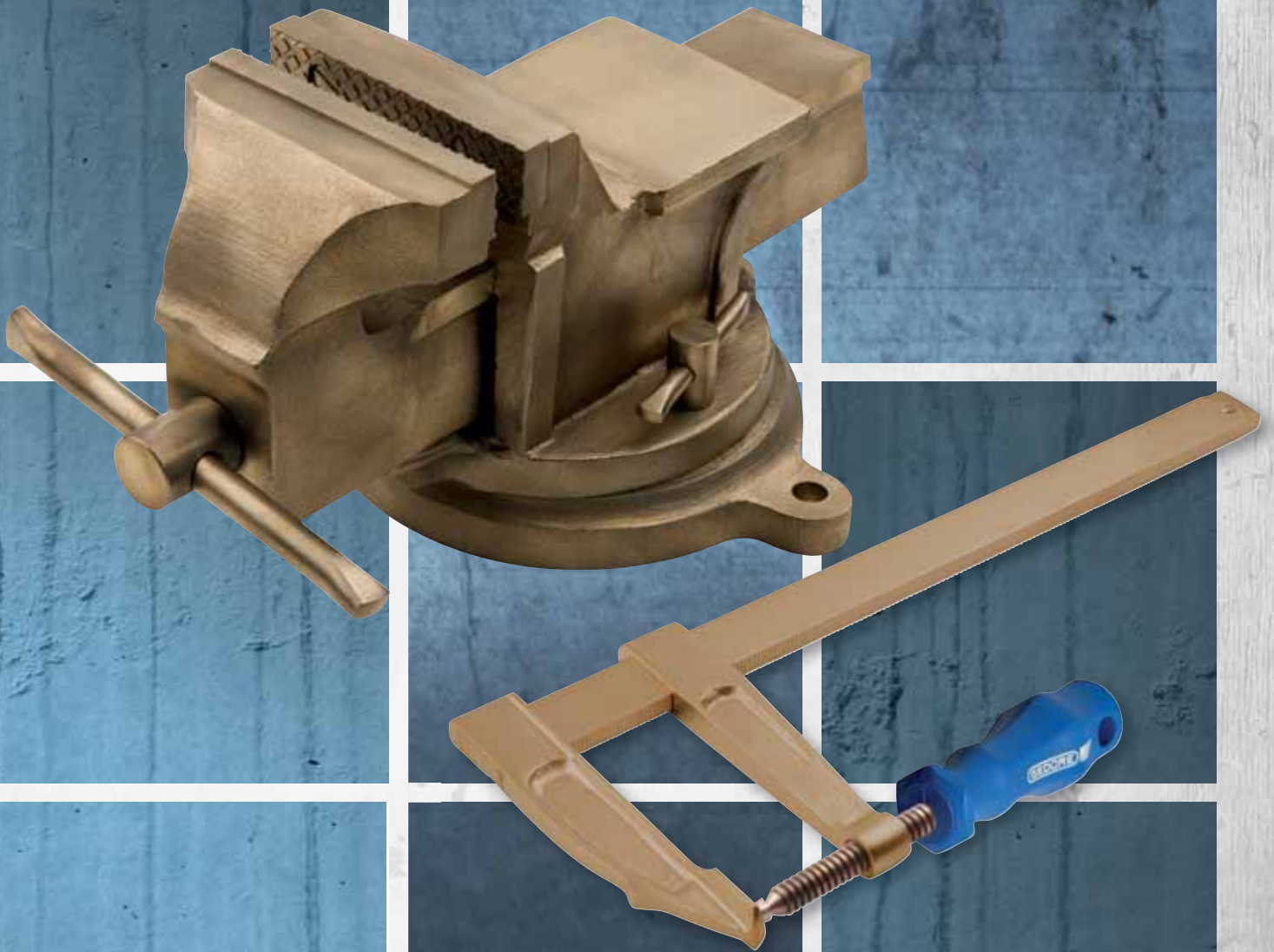

*funkenfrei

SONSTIGE HANDWERKZEUGE FUNKENFREI

GED110

BÜGELSÄGE

► Für Sägeblattlänge 300 mm



Code	No.	↳ mm ↲	↕ ↔
2515024	GED1100680S	560	900

GED111

SÄGEBLATT FÜR BÜGELSÄGE



Code	No.	↳ mm ↲	↕ ↔
2515288	GED1110300C	300	30

GED110

HANDSÄGE



Code	No.	↳ mm ↲	↕ ↔
2515105	GED1100681C	370	500

GED999

HANDSÄGE/FUCHSSCHWANZ



Code	No.	↳ mm ↲	↕ ↔
2495376	GED9991024C	700	770

GED771

ROHRABSCHNEIDER

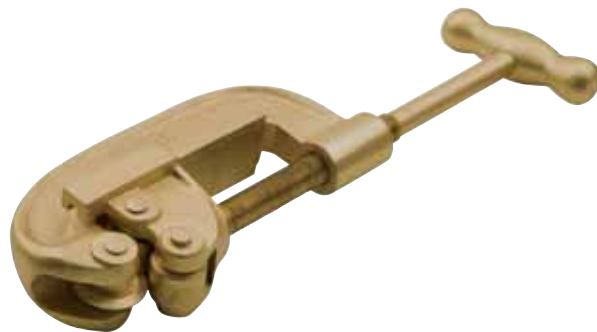

Code	No.	↳ mm ↲	bis Ø mm	↕ ↔
2509407	GED7710000S	430	50	2500

GED180

SCHRAUBZWINGE

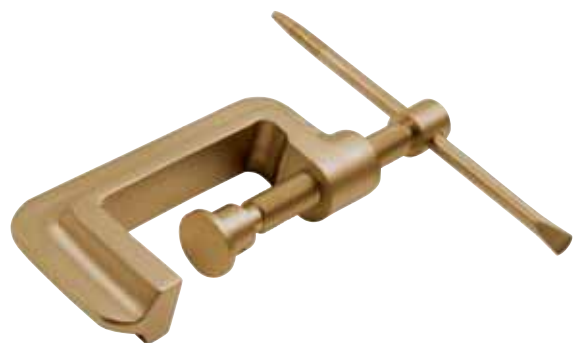

Code	No.	↳ mm ↲	mm 	↕ ↔
2512300	GED1800180S	180	80	3160
2512297	GED1800250S	250	120	4230
2512289	GED1800430S	430	270	13500

GED180

SPANN-SCHRAUBZWINGE



Code	No.	↳ mm ↲	mm 	↕ ↔
2498723	GED1800001S	480	130	2100



GED180

TIEFSPANN-SCHRAUBZWINGE



Code	No.	↳mm↳	mm	↕
2513080	GED1800002S	480	250	3700

GED156

PARALLEL-SCHRAUBSTOCK

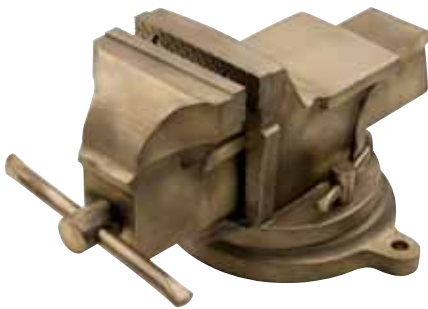

Code	No.	mm	mm	↕
2513528	GED1560090S	90	100	6500
2513501	GED1560125S	125	130	15500
2513498	GED1560150S	150	150	26500
2513471	GED1560170S	170	170	27400

GED721

EIMER



Code	No.	Liter	Material	↕
2509431	GED7210001S	10	Messing	1460
2505533	GED7210002S	12	Aluminium	740

GED170

FLACHFEILE



Code	No.	↳mm↳	Hieb	↕
2513854	GED1701265C	265	1	330
2513846	GED1703265C	265	3	330

GED171

HALBRUNDFEILE



Code	No.	↳mm↳	Hieb	↕
2511738	GED1711260C	260	1	340
2511711	GED1713260C	260	3	340

GED172

RUNDFEILE



Code	No.	↳mm↳	Hieb	↕
2514567	GED1721260C	260	1	175
2514540	GED1723260C	260	3	175

GED211

TASCHEN-MESSSCHIEBER

- ▶ Aus Messing
- ▶ mm Einteilung Nonius 1/20



Code	No.	↳mm↳	↕
2502801	GED2110000S	150	165



SPEZIALE



ARTIKEL



SPEZIALARTIKEL

*funkenfrei
SPARKING

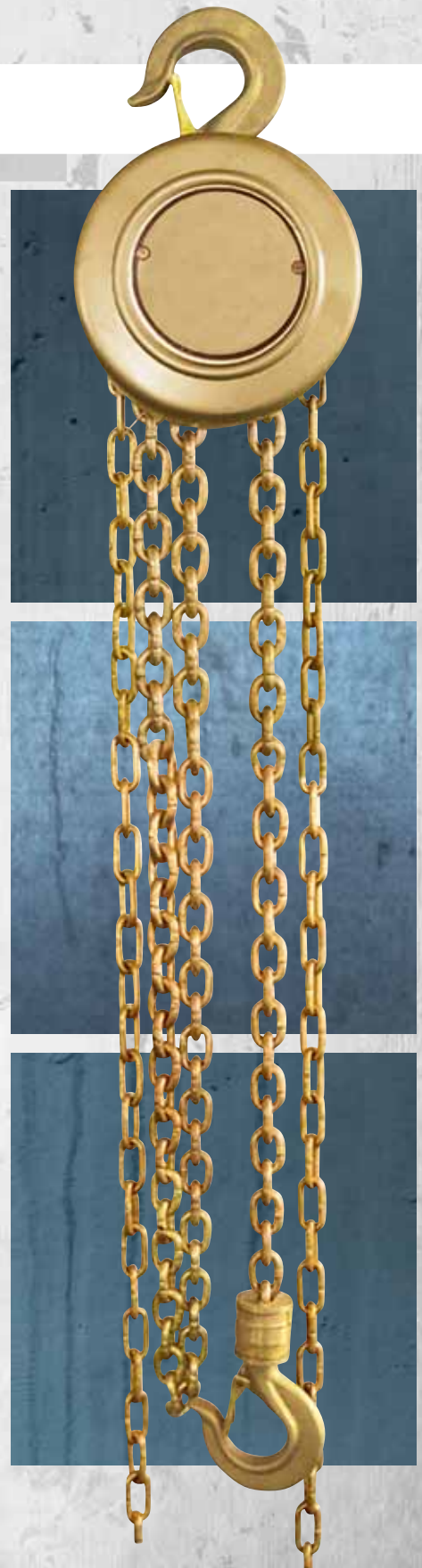

SPEZIALARTIKEL FUNKENFREI

GED181

SCHÄCKEL



Code	No.	Maße	↕
2514524	GED1810002C	30 x 40	100
2514516	GED1810003C	37 x 78	150

GED999

SICHERUNGSRING FÜR HAMMER



Code	No.	Verwendung
2516713	GED9991016S	> 2 kg
2516705	GED9991017S	2 - 6 kg

GED181

HÖRNADEL



Code	No.	↳mm↳	Ø	↕
2514508	GED1810006C	250	6	85
2514494	GED1810007C	300	8	150
2514486	GED1810008C	400	7	160
2513811	GED1810009C	500	10	335

GED181

HÖRNADEL MIT KUGELKOPF



Code	No.	↳mm↳	Ø	↕
2522012	GED1810005C	500	6	130

GED181

NADELN



Code	No.	↳mm↳	Ø	↕
2515091	GED1810004C	180	3	15

GED073

PINZETTE AUS KUNSTSTOFF



Code	No.	↳mm↳	↕
2499096	GED0731110S	100	15

GED073

PINZETTE SPITZ



Code	No.	↳mm↳	↕
2511819	GED0731111S	150	30

GED073

PINZETTE STUMPF



Code	No.	↳mm↳	↕
2510154	GED0731112S	100	30

GED186

FLANSLÖSER



Code	No.	a	b	c	d	↳mm↳	↕
2513277	GED1860018S	60	60	40	46	300	7200



GED724

ZUGMESSER

- Für Nacharbeiten und Anpassen von Kanthölzern und das Entrinden von Stämmen.



Code	No.	↳mm↳	Schneidenbreite	↳↳
2514834	GED7240004S	650	250	1500

GED999

TRAGBARE, HANDBETÄTIGTE ÖLPUMPE



Code	No.	↳mm↳	↳↳
2495368	GED9991057S	1350	5000

GED999

SPIRALBOHRER



Code	No.	↳mm↳	∅	↳↳
2515504	GED9991060C	100	6	20
2515490	GED9991061C	120	7	30
2515482	GED9991062C	140	8	50
2515474	GED9991063C	160	9	75
2515342	GED9991064C	180	10	100
2515334	GED9991065C	200	11	120
2515326	GED9991066C	220	12	170
2515318	GED9991067C	240	13	220
2515296	GED9991068C	260	14	280
2515261	GED9991069C	280	15	360
2515253	GED9991070C	300	16	440
2515245	GED9991071C	300	17	500
2515237	GED9991072C	320	18	600
2515229	GED9991073C	320	19	700
2515210	GED9991074C	330	20	800

GED999

SPIRALBOHRER-SATZ 15-teilig



Code	No.	Inhalt	↳↳
2513730	GED9991075C	6 / 7 / 8 / 9 / 10 / 11 / 12 / 13 / 14 / 15 / 16 / 17 / 18 / 19 / 20 mm	4000

GED999

HUBWAGEN

- Ladekapazität ca. 2000 kg
- Länge Gabeln ca. 1100 mm
- Länge Führungsstange ca. 1250 mm



Code	No.	↳↳
2515598	GED9991081S	12000

GED999

FLASCHENZUG



Code	No.	Ausführung	max. t	↳↳
2521482	GED9991018S	2 Ketten à 2,5 m	0,5	10200
2495406	GED9991019S	2 Ketten à 2,5 m	1,0	13600
2521474	GED9991020S	2 Ketten à 2,5 m	1,5	15600
2495392	GED9991021S	2 Ketten à 2,5 m	2,0	22000
2502593	GED9991022S	2 Ketten à 3 m	3,0	23600
2502585	GED9991023S	2 Ketten à 3 m	5,0	36000
2498553	GED9991055S	2 Ketten à 3 m	10,0	68500
2498545	GED9991056S	2 Ketten à 3 m	16,0	187000



ARTIKEL INDEX

Artikel	Seite
---------	-------

A

Abisolierzange	62
Arbeitsschere	63
Aufsätze 25 mm Ø	70
Aufsätze 40 mm Ø	70
Aufsätze 50 mm Ø	70
Aufsätze 65 mm Ø	71
Aufsätze 75 mm Ø	71
Aufsteckrohr für Zugringschlüssel	24
Axt	86

B

Bauknarre, 6-kant, mit Zentrierspitze	33
Beil	86
Besen	82
Betonmeißel	71
B-Handradschlüssel	28
Blech-Doppelmaulschlüssel	14
Blech-Doppelmaulschlüssel klein	13
Blech-Doppelmaulschlüssel ZOLL	14
Blech-Doppelmaulschlüssel-Satz klein, 10-teilig	13
Blechscherer	63
Bolzenschneider	63
Brechstange	93, 94
Breitspachtel	79
Bügelsäge	98
Bürste	82

C

Crimpzange	63
------------	----

D

Doppelmaulschlüssel	12
Doppelmaulschlüssel ZOLL	13
Doppelmaulschlüssel-Satz ZOLL, 8-teilig	13
Doppelmaulschlüssel-Satz, 12-teilig	12
Doppelringschlüssel gekröpft	17
Doppelringschlüssel gekröpft ZOLL	18
Doppelringschlüssel gerade	18
Doppelringschlüssel gerade ZOLL	19
Doppelringschlüssel-Satz gekröpft ZOLL, 8-teilig	18
Doppelringschlüssel-Satz gekröpft, 12-teilig	17
Drahtbürste	82
Drehstift für 6-kant-Steckschlüssel	30, 31
Drehstift für Klauenschlüssel	32
Dreikant-Plattenschaber	77
Dreikantschaber	77
Dunggabel	88
Durchtreiber	69, 72
Durchtreiber-Satz	73

E

Eck-Rohrzange	60
Eimer	99
Einmaulschlüssel	14

ARTIKEL INDEX

Artikel	Seite
---------	-------

Einmaulschlüssel ZOLL	15
Einreißhaken	86
Einringschlüssel gerade	19
Einringschlüssel gerade ZOLL	19

F

Fassheber	95
Faßschlüssel universal	28
Fäustel	66, 67
Feuerwehraxt	86
Feuerwehrbeil	86
Flachfeile	99
Flachmeißel	71
Flachschaber	77
Flachzange	62
Flanschkeil	92
Flanschlöser	102
Flanschmesser	93
Flaschenzug	103
Frankfurter Schaufel	87
Freilaufknarre mit 12-kant-Ring	33
Fugenkelle	79
Fußbodenschaber	79

G

Gabel für Schießbaumwolle	89
Gasrohrzange	60
Gelenkgriff 1"	44
Gelenkgriff 1/2"	38
Gelenkgriff 1/4"	36
Gelenkgriff 3/4"	42
Gelenk-Hakenschlüssel	27
Gewindereinigungsstift	73
Glättkelle	78
Grubenpickel	86
Gummihammer	69
Gummischieber	83

H

Hakenschlüssel	27
Halbrundfeile	99
Handbürste	82
Handfeger	82
Handhammer	67
Handpickel	86
Handradschlüssel	27
Handsäge	98
Handsäge/Fuchsschwanz	98
Handschaufel	88
Handschutzgriff	72
Haue	86
Hebestange	94
Heckenschere	89
Heugabel	89
Holzhammer	69
Hörnadel	102



ARTIKEL INDEX

Artikel	Seite
Hörnadel mit Kugelkopf	102
Hubwagen	103
I	
Idealschere	63
K	
Kanaldeckelhaken	29
Kanaldeckelhaken verstärkte Ausführung	29
Karbidtrommelöffner	95
Kardangeln 1"	45
Kardangeln 1/2"	39
Kardangeln 1/4"	37
Kardangeln 3/4"	42
Kardangeln für Kraftschraubereinsätze 1"	49
Kardangeln für Kraftschraubereinsätze 1/2"	47
Kardangeln für Kraftschraubereinsätze 3/4"	48
Keil	92
Kesselstein-/Entrostungshammer	68
Kettenrohrzange	60
Kisteneisen	93
Klappspaten	87
Klauenhämmer	68
Klauenschlüssel ohne Drehstift	32
Knarrenkasten 1"	45
Knarrenkasten 1/2"	40
Knarrenkasten 1/4"	37
Knarrenkasten 3/4"	43
Kneifzange	62
Kombinationszange	61
Kombinationszange, isoliert	61
Körner	73
Kraftschraubereinsatz 1"	49
Kraftschraubereinsatz 1" 6-kant	48
Kraftschraubereinsatz 1" 6-kant, lange Form	49
Kraftschraubereinsatz 1.1/2" 6-kant	50
Kraftschraubereinsatz 1.1/2" 6-kant, lange Form	50
Kraftschraubereinsatz 1/2"	46
Kraftschraubereinsatz 1/2" 6-kant	46
Kraftschraubereinsatz 1/2" 6-kant, lange Form	46
Kraftschraubereinsatz 2.1/2" 6-kant	51
Kraftschraubereinsatz 3/4"	48
Kraftschraubereinsatz 3/4" 6-kant	47
Kraftschraubereinsatz 3/4" 6-kant, lange Form	47
Kraft-Seitenschneider	61
Kraft-Seitenschneider, isoliert	61
Krähenfußschlüssel, Maulform, Vierkant 1/2"	33
Kreuzhacke	87
Kreuzmeißel	71
Kunststoffhammer	70
Kupplungsschlüssel	26
Kurbel 1"	45
Kurbel 1/2"	39
Kurbel 3/4"	43

ARTIKEL INDEX

Artikel	Seite
L	
Loch-/Durchschläger	68
M	
Maschinenhammer	68
Maurerhammer	68
Maurerkelle	78
Maurermeißel	71
Messer	76
Minenhammer	67
Montagedorn	73
Montagemaulschlüssel mit Dorn	25
Montagemaulschlüssel mit Dorn ZOLL	25
Montagemaulschlüssel mit Dorn ZOLL, gekröpft	26
Montagemaulschlüssel mit Dorn, gekröpft	25
Montageringschlüssel mit Dorn ZOLL, gekröpft	26
Montageringschlüssel mit Dorn, gekröpft	26
Montagezange für Außensicherungsringe	62
Montagezange für Innensicherungsringe	63
Montiereisen	94
Montierhebel	94, 95
Montierspitze	73
N	
Nadeln	102
Nageleisen/Knippeisen	93
Nasenkeil	92
O	
Ölpumpe, tragbar, handbetätigt	103
P	
Parallel-Schraubstock	99
Pinselfbürste	83
Pinzette aus Kunststoff	102
Pinzette spitz	102
Pinzette stumpf	102
Plattenschaber	79
Q	
Quergriff 1"	44
Quergriff 1/2"	39
Quergriff 1/4"	36
Quergriff 3/4"	42
R	
Randschaufel	88
Rechen	89
Reduzierstück 1" - 3/4"	45
Reduzierstück 1/2" - 1/4"	39
Reduzierstück 3/4" - 1/2"	42
Reduzierstück für Kraftschraubereinsätze 1" - 3/4"	49
Reduzierstück für Kraftschraubereinsätze 1.1/2" - 1"	50
Reduzierstück für Kraftschraubereinsätze 1/2" - 1/4"	47
Reduzierstück für Kraftschraubereinsätze 2.1/2" - 1.1/2"	51



ARTIKEL INDEX

Artikel	Seite
Reduzierstück für Kraftschraubereinsätze 3/4" - 1/2"	48
Reinigungswerkzeug	79
Reißnadel	72
Ring-Maulschlüssel	15
Ring-Maulschlüssel gekröpft	17
Ring-Maulschlüssel ZOLL	16
Ring-Maulschlüssel, extra lang	16
Ring-Maulschlüssel-Satz	15
Ring-Maulschlüssel-Satz gekröpft	17
Ring-Maulschlüssel-Satz ZOLL	16
Ring-Maulschlüssel-Satz, extra lang	16
Rohrabschneider	98
Rohrzange, amerikanisches Modell	60
Rohrzange, schwedisches Modell	60
Roststecher	78
Rückschlagfreie Halterung	70
Rückschlagfreier Hammer	69, 70
Rundbürste	83
Rundfeile	99
Rundzange	61

S

3-kant-Steckschlüssel	28
3-kant-Steckschlüsseleinsatz 1/2"	28
4-kant-Steckschlüssel gewinkelt	28
6-kant-Steckschlüssel	29
6-kant-Steckschlüssel doppelseitig	31
6-kant-Steckschlüssel gewinkelt	30
6-kant-Steckschlüssel mit festem Quergriff	31
Sägeblatt für Bügelsäge	98
Schaber	78
Schaber konkav	78
Schaber mit Stiel	78
Schaberspachtel	76
Schäkel	102
Schieberklaue	27
Schlag-Maulschlüssel	20
Schlag-Maulschlüssel ZOLL	20
Schlag-Ringschlüssel	21
Schlag-Ringschlüssel gekröpft	22
Schlag-Ringschlüssel ZOLL	21
Schlegel	68
Schlitzmeißel	71
Schlosserhammer	66, 67
Schlüssel für Tankwagenventil	28
Schraubendreher	54
Schraubendreherbit 1/4"	51
Schraubendrehereinsatz 1"	45
Schraubendrehereinsatz 1/2"	40
Schraubendrehereinsatz 1/2", lang	41
Schraubendrehereinsatz 3/4"	43
Schraubendrehereinsätze-Kasten 1/2"	41
Schraubendreher-Sätze	54
Schraubzwinde	98
Schrotmeißel	69
Schrubber	82

ARTIKEL INDEX

Artikel	Seite
Sechskantschraubendreher mit Griff	55
Sechskantschraubendreher mit T-Griff	57
Sechskantschraubendreher mit T-Griff, lang	57
Seitenschneider	61
Setzhammer	67
Sichel	89
Sicherungsring für Hammer	102
Sicherungsring für Kraftschraubereinsätze 1"	49
Sicherungsring für Kraftschraubereinsätze 1.1/2"	50
Sicherungsring für Kraftschraubereinsätze 1/2"	47
Sicherungsring für Kraftschraubereinsätze 2.1/2"	51
Sicherungsring für Kraftschraubereinsätze 3/4"	48
Sicherungsstift für Kraftschraubereinsätze 1"	49
Sicherungsstift für Kraftschraubereinsätze 1.1/2"	50
Sicherungsstift für Kraftschraubereinsätze 1/2"	47
Sicherungsstift für Kraftschraubereinsätze 2.1/2"	51
Sicherungsstift für Kraftschraubereinsätze 3/4"	48
Space-Eisen	92
Spachtel	76
Spachtelmesser	77
Spann-Schraubzwinde	98
Spaten	87
Spatengabel	88
Spezial-Universalschlüssel	29
Spezialverlängerung für Krähenfußschlüssel 1/2"	33
Spiralbohrer	103
Spiralbohrer-Satz	103
Spitzhacke	87
Spitzkelle	79
Spitzmeißel	71
Splinttreiber	73
Splinttreiber-Satz	73
Spritzkabinenschaber	77
Steckschlüssel mit Griff	32
Steckschlüssel mit Griff ZOLL	32
Steckschlüsseleinsatz 1" 6-kant	44
Steckschlüsseleinsatz 1" 6-kant ZOLL	44
Steckschlüsseleinsatz 1/2" 6-kant	37
Steckschlüsseleinsatz 1/2" 6-kant ZOLL	38
Steckschlüsseleinsatz 1/2" 6-kant, lange Form	38
Steckschlüsseleinsatz 1/4" 6-kant	36
Steckschlüsseleinsatz 3/4" 6-kant	41
Steckschlüsseleinsatz 3/4" 6-kant ZOLL	41
Steinkeil	92
Stirnlochschlüssel	27
Strickeisen/Strickwerkzeug	76

T

Taschen-Messschieber	99
Telefonzange	62
Telefonzange, isoliert	62
T-Gelenkschlüssel 1"	45
T-Gelenkschlüssel 1/2"	40
T-Gelenkschlüssel 3/4"	43
T-Griff 1/2"	39
T-Griff 3/4"	43

ARTIKEL INDEX

Artikel	Seite
Tiefspann-Schraubzwinge	99
Topfbürste	83
U	
Umschaltknarre 1"	44
Umschaltknarre 1/2"	38
Umschaltknarre 1/4"	36
Umschaltknarre 3/4"	42
Universalschlüssel	28

V

Ventilhaken	27
Verbindungsvierkant 1"	45
Verbindungsvierkant 1/2"	39
Verbindungsvierkant 1/4"	37
Verbindungsvierkant 3/4"	42
Vergrößerungsstück 1/2" - 3/4"	39
Vergrößerungsstück 1/4" - 1/2"	36
Vergrößerungsstück 3/4" - 1"	42
Vergrößerungsstück für Kraftschraubereinsätze 1" - 1.1/2"	49
Vergrößerungsstück für Kraftschraubereinsätze 1/2" - 3/4"	46
Vergrößerungsstück für Kraftschraubereinsätze 3/4" - 1"	48
Verlängerung 1"	44
Verlängerung 1/2"	38
Verlängerung 1/4"	36
Verlängerung 3/4"	42
Verlängerung für Kraftschraubereinsätze 1"	49
Verlängerung für Kraftschraubereinsätze 1/2"	46
Verlängerung für Kraftschraubereinsätze 3/4"	48
Verschlagöffner	95
Verstellbare Kombinationszange	61
Verstellbarer Einmaulschlüssel	60
Verstellbarer Schraubenschlüssel	60
Vielzweckschere	63
Vierkant-Ahle	72
Vierkantgriff 1/4"	36
Vornschneider	62
Vorschlaghammer	66

W

Wasserpumpenzange	61
Winkeldorn	72
Winkelgriff 1"	45
Winkelgriff 1/2"	39
Winkelgriff 3/4"	43
Winkelschaber	77
Winkelschaber mit Griff	77
Winkelschraubendreher	56, 57
Winkelschraubendreher-Satz	55

Z

Zahnradknarre mit Durchsteckvierkant 1"	44
Zahnradknarre mit Durchsteckvierkant 1/2"	38
Zahnradknarre mit Durchsteckvierkant 1/4"	36
Zahnradknarre mit Durchsteckvierkant 3/4"	42
Zangen-Satz	63

ARTIKEL INDEX

Artikel	Seite
Zugdorn	73
Zugmaulschlüssel	22
Zugmaulschlüssel ZOLL	23
Zugmesser	103
Zugringschlüssel	24
Zugringschlüssel ZOLL	24
Zugringschlüssel-Satz, 18-teilig	24
Zündkerzenbürste	83
Zylinderbürste	83



ARTIKEL INDEX	
Artikel	Seite
108 UNI.....	72
226 E.....	69
227 E.....	69
228	69
GED	51
GED000.....	89
GED001.....	12
GED0010.....	12, 13, 21, 22
GED0010.....	70
GED0017.....	13
GED00171.....	14
GED00171.....	99
GED00172.....	13
GED00172.....	99
GED0020.....	14
GED0020.....	70
GED0020.....	95
GED0021.....	15
GED003.....	20
GED009.....	19
GED011.....	17, 18
GED012.....	18, 19
GED0130.....	15
GED0137.....	16, 17
GED0137.....	77
GED01373.....	25, 26
GED01374.....	33
GED01375.....	26
GED01376.....	32, 33
GED014.....	57
GED0150.....	28, 29
GED0150.....	88
GED025.....	55, 56, 57
GED0251.....	29, 30
GED027.....	24
GED0300.....	28
GED031.....	22, 23
GED0340.....	30, 31
GED0341.....	28, 32
GED035.....	36, 37, 38, 41, 44
GED035.....	46, 47, 48, 49, 50, 51
GED0351.....	46, 47, 48, 49
GED0359.....	28
GED0360.....	36, 38, 42, 44
GED0370.....	39, 43
GED04.....	42
GED0400.....	36, 37, 39, 40, 42, 43, 44, 45
GED0410.....	36, 38, 42, 44
GED042.....	38, 44
GED0421.....	36
GED0430.....	37, 40, 43, 45
GED0440.....	40, 41, 43, 45
GED048.....	60
GED050.....	61
GED051.....	60
GED052.....	60

ARTIKEL INDEX	
Artikel	Seite
GED053.....	60
GED055.....	60
GED060.....	61
GED061.....	62
GED062.....	61, 63
GED063.....	62
GED064.....	62
GED065.....	60
GED066.....	61
GED068.....	62
GED069.....	63
GED0712.....	63
GED073.....	102
GED073.....	76
GED080.....	54, 55, 57
GED081.....	54
GED081.....	72
GED083.....	57
GED090.....	27
GED091.....	27
GED092.....	95
GED100.....	66
GED102.....	67
GED103.....	66, 67
GED104.....	66
GED105.....	68
GED106.....	68
GED108.....	67
GED109.....	67
GED110.....	98
GED111.....	98
GED112.....	68
GED113.....	67
GED115.....	71
GED116.....	68, 71
GED117.....	73
GED118.....	72, 73
GED119.....	73
GED120.....	72, 73
GED121.....	83
GED125.....	87
GED126.....	87
GED131.....	78, 79
GED132.....	78
GED133.....	78
GED134.....	79
GED135.....	77
GED136.....	73
GED136.....	77
GED138.....	77
GED139.....	76, 78, 79
GED140.....	76
GED145.....	86
GED146.....	86
GED15.....	70
GED151.....	88, 89



ARTIKEL INDEX

Artikel	Seite
GED152.....	87
GED153.....	87
GED156.....	99
GED160.....	61
GED160.....	93, 94
GED161.....	93
GED162.....	73
GED162.....	94
GED163.....	94, 95
GED170.....	99
GED175.....	82, 83
GED176.....	82, 83
GED177.....	83
GED178.....	83
GED179.....	83
GED180.....	98, 99
GED181.....	102
GED185.....	92
GED186.....	102
GED186.....	92
GED190.....	76
GED195.....	72
GED211.....	99
GED25.....	71
GED30.....	71
GED700.....	27
GED701.....	27
GED701.....	68
GED702.....	27
GED702.....	63
GED702.....	68
GED703.....	26, 27
GED703.....	68
GED704.....	69
GED705.....	69
GED708.....	71
GED709.....	71
GED710.....	71
GED711.....	71
GED712.....	92
GED714.....	77
GED715.....	78
GED716.....	86
GED717.....	86
GED718.....	86
GED719.....	86
GED720.....	93
GED721.....	99
GED722.....	60
GED723.....	76, 79
GED724.....	103
GED724.....	95
GED7240.....	29
GED725.....	63
GED771.....	98
GED999.....	102, 103

ARTIKEL INDEX

Artikel	Seite
GED999.....	63
GED999.....	77
GED999.....	98
GED9991.....	28
GEDSDS.....	70
GEDSFN.....	69
GEDSPI.....	70
GEDSPS.....	70
GEDSTPN.....	70



Kontakt

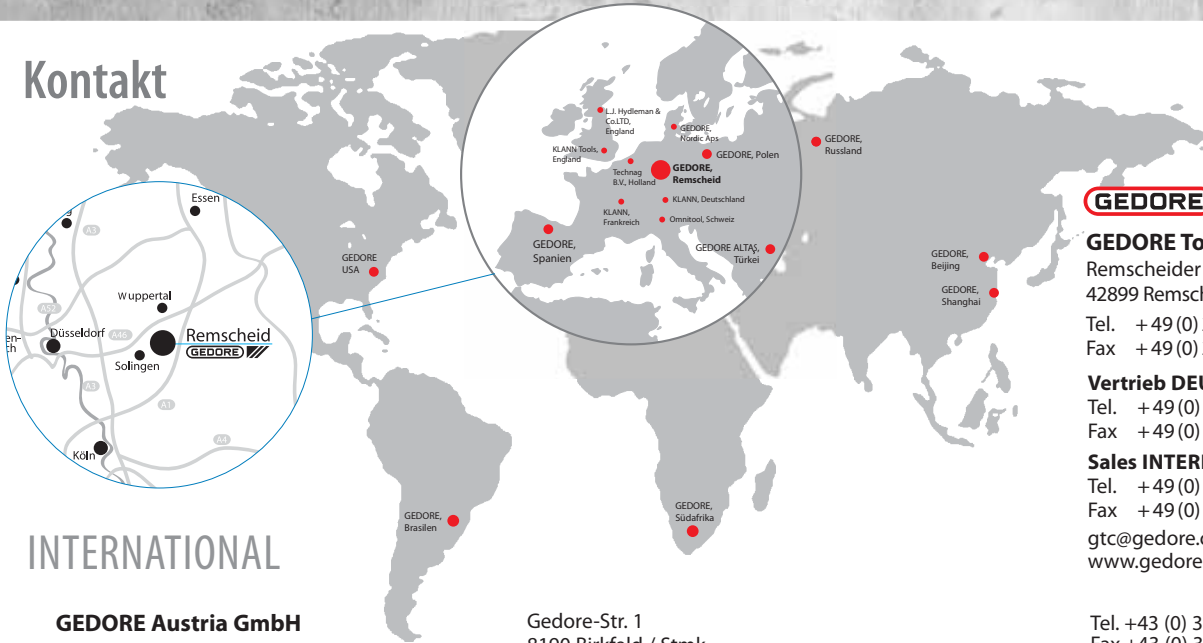

GEDORE Tool Center KG

Remscheider Straße 149
42899 Remscheid · GERMANY
Tel. +49 (0) 21 91-596-0
Fax +49 (0) 21 91-596-230

Vertrieb DEUTSCHLAND
Tel. +49 (0) 21 91-596-900
Fax +49 (0) 21 91-596-999

Sales INTERNATIONAL
Tel. +49 (0) 21 91-596-910
Fax +49 (0) 21 91-596-911
gtc@gedore.com
www.gedore.com

Tel. +43 (0) 3174 / 363 60
Fax +43 (0) 3174 / 363 83 20
verkbirkfeld@gedore.at
www.gedore.at

INTERNATIONAL

GEDORE Austria GmbH

Gedore-Str. 1
8190 Birkfeld / Stmk.
Austria

GEDORE IBÉRICA S.L.

Arangutxi 12
Poligono Industrial de Júndiz
01015 Vitoria Alava
Spain

Tel. +34-902-29 22 62
Fax +34-945-29 21 99
gedore@gedore.es
www.gedore.es

GEDORE-KLANN France SARL

Z.I. des Béthunes / St Ouen l'Aumône
10 Rue du Bois du Pont, B.P. 79144
95074 Cergy Pontoise Cedex
France

Tel. +33 (0) 1 34 40 16 60
Fax +33 (0) 1 34 40 16 61
info-klann@gedore.fr
www.gedore.fr www.klann.fr

OMNITOOL GmbH

Fluestr. 25
8957 Spreitenbach
Switzerland

Tel. +41 (0) 56 / 418 40 50
Fax +41 (0) 56 / 418 40 55
omnitool@gedore.de
www.omnitool.ch

GEDORE UK Limited

Marton Street
SKIPTON BD23 1TF
North Yorkshire
United Kingdom

Tel. +44 (0) 1756 / 70 67 00
Fax +44 (0) 1756 / 79 80 83
sales@hydlemans.co.uk
www.gedore.com

TECHNAG B.V.

Flemingweg 7
2408 AV Alphen aan den Rijn
Netherlands

Tel. +31 (0) 172 / 42 73 50
Fax +31 (0) 172 / 42 73 60
info@technag.nl
www.gedore.nl

GEDORE POLSKA Sp. z o.o.

ul. Żwirki i Wigury 56a
43-190 Mikołów
Poland

Tel. +48 (0) 32 / 738-40 10
Fax +48 (0) 32 / 738-40 20
gedore@gedore.pl
www.gedore.pl

GEDORE Moskau GmbH

Novatorov Str. 1
119421 Moskau
Russia

Tel. +7 (0) 495 / 748 2000
Fax +7 (0) 495 / 988 5757
info@gedore.ru
www.gedore.ru

GEDORE TOOLS, INC.

7187 Bryhawke Circle, Suite 700
North Charleston, SC 29418
USA

Tel. +1-843 / 225 50 15
Fax +1-843 / 225 50 20
support@gedoretools.com
www.gedoretools.com

GEDORE Nordic ApS

Haderslevvej 88
6000 Kolding
Dänemark

Tel. +45 29808404
tim.lissau@gedore.com
www.gedore.com

GEDORE Tool Trading (Shanghai) Co., Ltd.

Building # 76, 3700 Huaning Road
Xinzhuan Industrial Zone,
Minhang District Shanghai 201108 P.R. China

Tel. +86-21-51 59 18 57
Fax +86-21-51 59 18 58
Service Hotline: 400 880 1858
info@gedore.cn
www.gedore.cn

GEDORE Tools (Beijing) Co., Ltd.

Floor 2, Building 16, Area 7
Advanced Business Park
188 South 4th Ring Road
Fengtai District
100070 Beijing, P.R. China

Tel. +86-10-83 61 36 21
Fax +86-10-63 70 13 00
Service Hotline: 400 880 1858
www.gedore.cn

Ferramentas GEDORE do Brasil S.A.

Rua Vincentina Maria Fidelis, 275
CEP 93025-340 Sao Leopoldo-RS
Südamerika / Brasilien

Tel. +55 51-3589-9200
Fax +55 51-3589-9222
sales@gedore.com.br
www.gedore.com.br

GEDORE Tools S.A. (Pty) Ltd.

P.O. Box 68
3620 New Germany
Afrika / Südafrika

Tel. +27 (0) 31/ 705 3587
Fax +27 (0) 31/ 705 3277
general@gedoresa.co.za
www.gedore.co.za

Impressum

ALLGEMEINES INFO

Dieser Katalog ersetzt alle vorherigen Ausgaben (Preislisten und Kataloge).
Fotos und technische Angaben entsprechen dem augenblicklichen Stand.

Im Zuge der Verbesserung und Anpassung an den Stand der Technik behalten wir uns Änderungen im Hinblick auf Aussehen, Abmessungen (immer in „mm“, sofern keine andere Angabe), Gewichte und Eigenschaften sowie Leistungen vor. Damit ist kein Anspruch auf Korrektur oder Nachlieferung bereits gelieferter Produkte verbunden. Streichungen können jederzeit vorgenommen werden, ohne dass ein rechtlicher Anspruch entsteht.

Alle Hinweise zur Benutzung und Sicherheit sind unverbindlich. Sie ersetzen keinesfalls irgendwelche gesetzlichen oder berufsgenossenschaftlichen Vorschriften.

Für Druckfehler übernehmen wir keine Haftung. Im Lieferumfang ist keine Dekoration (Werkzeuge, etc.) enthalten.

Ein Nachdruck, auch auszugsweise, bedarf der vorherigen schriftlichen Zustimmung durch GEDORE.
Alle Rechte weltweit vorbehalten.

Wir verweisen auf unsere aktuellen Rahmen- und Konditionsvereinbarungen sowie auf unsere Liefer- und Zahlungsbedingungen unter www.gedore.com



GEDORE Tool Center KG
Remscheider Straße 149
42899 Remscheid · GERMANY
Postfach 120361
42873 Remscheid
Fon +49 (0) 21 91-596-0
Fax +49 (0) 21 91-596-230
Amtsgericht Wuppertal, HRA 17944

Gesamtkonzeption, grafische Realisation und Gestaltung:
GEDORE Tool Center KG, Remscheid

© Copyright by GEDORE Remscheid



Werkzeuge fürs Leben · Tools for life



GEDORE Tool Center KG

Remscheider Straße 149
42899 Remscheid · GERMANY
Postfach 120361 · 42873 Remscheid

Fon +49 (0) 21 91 - 596 - 0
Fax +49 (0) 21 91 - 596 - 230

gtc@gedore.com · www.gedore.com

Vertrieb DEUTSCHLAND

Fon +49 (0) 21 91 - 596 - 900 · Fax +49 (0) 21 91 - 596 - 999

Sales INTERNATIONAL

Fon +49 (0) 21 91 - 596 - 910 · Fax +49 (0) 21 91 - 596 - 911

Amtsgericht Wuppertal, HRA 17944

www.gedore.com